



**AMAZONE**

**UX**



# UX trailed sprayers

Our competence is your success



- ✔ From choice, all new AMAZONE sprayers can be provided with an official sprayer proficiency certificate. The proficiency certificate meets current EU regulations according to EN ISO 16122, which is, for European member states, supported also with the CEMA label.

With the UX product range, AMAZONE offers trailed sprayers with tank capacities from 3,200 l to 11,200 l. Thanks to their highly precise application and outstanding capacity, and with boom widths from 15 to 40 m, the UX trailed sprayers are particularly efficient in both work in the field and on the road.



## UX

efficient – precise – comfortable

	Page
The models	4
Frame   Drawbar   Drawbar mounting   Towing eyes   Hydraulic parking jack	10
Axles and brakes   Underbelly cover	12
AutoTrail steering systems	14
Tank   Main agitator   XtremeClean intensive cleaning system	16
UX Special	18
UX Super	24
UX 11200	34
Booms	44
Part-width section control	60
Nozzles	68
Equipment	70
ISOBUS	72
Technical data	82



# Introducing a comprehensive family

The right solution for all applications

No matter whether you choose the UX Special, a UX Super or the flagship UX 11200, all of the UX trailed sprayers ensure a first-class performance and comfortable operation.

Thanks to the comprehensive equipment possibilities, you can match UX trailed sprayers to any operational conditions.

## UX Special

Model	Working width	Nominal volume	Pump capacity
UX 3200 Special	15 – 36 m	3,200 l	260 l/min / 380 l/min
UX 4200 Special	15 – 36 m	4,200 l	260 l/min / 380 l/min
UX 5200 Special	15 – 36 m	5,200 l	380 l/min



UX 3200 Special

## UX Super

Model	Working width	Nominal volume	Pump capacity
UX 4201 Super	21 – 40 m	4,200 l	520 l/min (2 x 260 l/min)
UX 5201 Super	21 – 40 m	5,200 l	520 l/min (2 x 260 l/min)
UX 6201 Super	21 – 40 m	6,200 l	520 l/min (2 x 260 l/min)



UX 5201 Super



UX 11200

## UX 11200

Model	Working width	Nominal volume	Pump capacity
UX 11200	24 – 40 m	11,200 l	750 l/min (3 x 250 l/min)

# UX Special trailed sprayer

## Super-S2 and Super-L2

sprayer booms in lightweight design



Boom widths from

# 15 to 30 m



### The advantages at a glance:

- ⊕ Low transport height and overall compact transport dimensions through an innovative tank and boom design
- ⊕ Light, compact, manoeuvrable – compact design and drawbar steering or axle steering with a steering angle up to 20°
- ⊕ SmartCenter: tailored operating solutions – from the easy-to-handle Standard-Pack up to the remotely-controlled system with Comfort-Pack
- ⊕ High capacity induction bowl for maximum fill times and homogenous spray liquid mixing
- ⊕ High-capacity, self-priming, low maintenance piston diaphragm pump for large application rates even at high spray pressures
- ⊕ Fully automatic DistanceControl boom guidance
- ⊕ DUS or DUS pro pressure recirculation systems ensure continuous circulation of the spray agent
- ⊕ 50 cm part-width sections and optimum nozzle choice thanks to the electric AmaSwitch or AmaSelect individual nozzle controls
- ⊕ Automatic wash-out programmes for top cleaning results

Single pump system with a capacity of  
**260 or 380 l/min**

Spray agent tank from  
**3,200 to 5,200 litres**



UX 3200 Special  
with 24 m Super-L2 boom

The UX Special trailed with tank capacities of 3,200, 4,200 and 5,200 litres, is characterised above all by its robust and user-friendly design. Boom widths from 15 to 36 m are possible with the Super-S2 or Super-L2 booms. The UX Special meets the highest demands for modern plant protection thanks to the extensive range of high-quality optional equipment.



**MORE INFORMATION**  
[www.amazone.net/ux-special](http://www.amazone.net/ux-special)

# UX Super trailed sprayer

Dual pump system with a capacity of

## 520 l/min

## Super-L2 Super-L3

sprayer boom in a lightweight design



With boom widths of

## 21 to 40 m



### The advantages at a glance:

- ⊕ Low transport height and overall compact transport dimensions through an innovative tank and boom design
- ⊕ Light, compact, manoeuvrable – compact design and axle steering with a steering angle up to 28°
- ⊕ Dustproof storage compartments on the left and right hand side
- ⊕ Tailored SmartCenter operator solutions – from the intuitively-operated Standard-Pack up to the Comfort-Pack plus with pressure sensitive touch screen. Anything is possible!
- ⊕ High-capacity, self-priming, low maintenance piston diaphragm pumps with a delivery capacity up to 520 l ensure high application rates even at high spray pressures
- ⊕ DistanceControl fully automatic boom guidance
- ⊕ **For difficult terrain conditions:**
  - CountourControl active boom guidance for the optimum vertical boom guidance
  - SwingStop active boom tip swing compensation to reduce horizontal boom movements
- ⊕ DUS or DUS pro pressure recirculation systems ensure continuous circulation of the spray agent
- ⊕ 50 cm part-width sections and optimum nozzle choice thanks to the electric AmaSwitch and AmaSelect individual nozzle control
- ⊕ Automatic wash-out programmes for perfect cleaning results under all conditions



Spray agent tank from

**4,200 to 6,200 litres**



Axle steering  
with **28°**  
steering angle

UX 5201 Super  
with 36 m Super-L2 boom

The UX Super trailed sprayer, in tank capacities of 4,200 l, 5,200 l and 6,200 l, is characterised particularly by its very comfortable handling concept. The Super-L2 and Super-L3 sprayer booms, in widths from 21 to 40 m, impress with their first-class boom guidance. Thanks to the level of high-performance equipment offered, the UX Super trailed sprayer ensures maximum efficiency at an unprecedented output.



**MORE INFORMATION**  
[www.amazone.net/ux-super](http://www.amazone.net/ux-super)

# Perfect down to the last detail



**✔ The frame – strong and yet elastic!**

The wide profile, steel frame, made from torsion resistant steel, compact tank design and the well-engineered boom technology provide the utmost in robustness

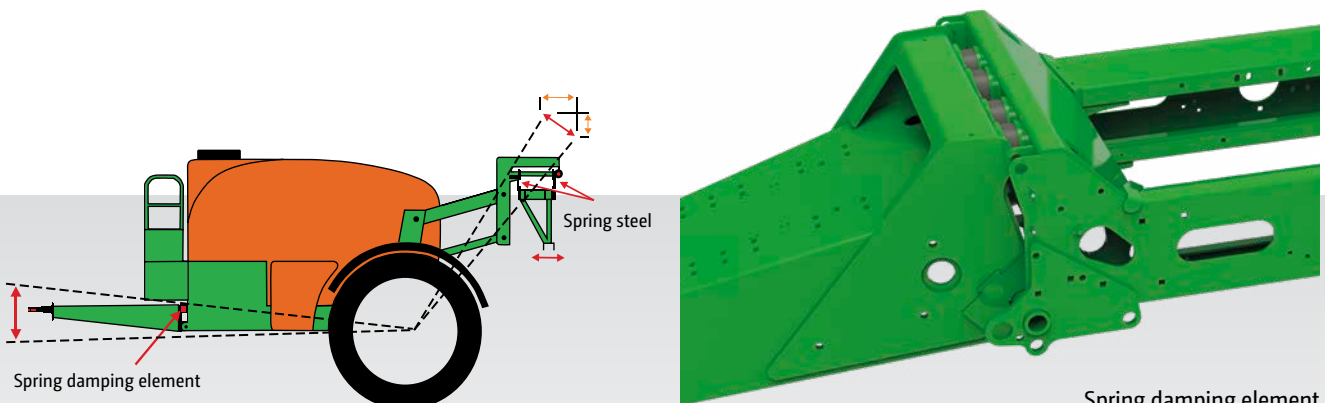

Spring damping element between the drawbar and the frame



Top mounted drawbar with towing eye and hydraulic parking jack



Lower mounted drawbar with towing eye and mechanical parking jack

## Drawbar damping – For protection of the booms

All drawbars are provided with the drawbar shock absorbance system, an important design element in the UX. Minimising the to and fro movements between frame and drawbar it also protects the booms and prevents any rocking movement of the tractor keeping the operator comfortable.

## Hydraulic parking jack

A height adjustable jack is integrated in the frame and with its convenient optional hydraulic height adjustment makes coupling to the tractor quick and easy.

- ✔ Optional also on the UX Special
- ✔ Standard on the UX Super and UX 11200



## Linking to the tractor – Just as you like it!

No matter whether using a rigid hitch drawbar with ball coupling or the classic towing eye, AMAZONE always offers the right solution for your tractor. Make a choice between top or lower mounting, between 40 mm or 50 mm diameter towing eyes, or the K 80 ball coupling.

## Towing eyes

The UX trailed sprayer offers the ability to have a drawbar fitted to the rear with a towing capacity of up to 12 t.

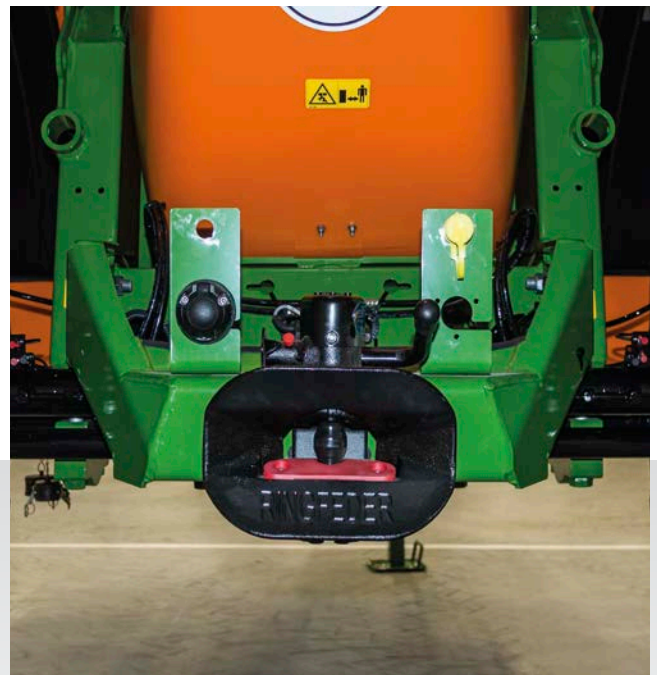

# Discover the possibilities





Rigid axle with track widths of 1.50 m to 2.25 m



Adjustable axle with stepless track width adjustment from 1.50 m to 2.25 m

## Axles and brakes – Safety first!

With permissible speeds of up to 60 km/h and the ALB system (automatic load dependent braking) the UX trailed sprayers are ideally suited for on the road. Thanks to tyres of up to 520/85 R46 (2.05 m diameter), the ground pressure is kept at a minimum. The track width of the rigid axles is available from choice from 1.50 m to 2.25 m. In addition, the large ground clearance of up to 82 cm leads to a versatile plant protection operation. By reversing the wheels, two track widths can be achieved.

The adjustable axles on the UX 3200 and UX 4200 provide the highest flexibility due to their stepless track width adjustment from 1.50 m to 2.25 m. For extreme conditions, there is a hydro-pneumatic sprung axle option with patented roll stabilisation. AutoTrail axle steering offers the driver the highest level of comfort due to the elegant control via the multi-function joystick AmaPilot.

## Underbelly covers

Thanks to the underbelly cover, the complete underside is encased in stainless steel plates so that axles, chassis and plants are optimally protected.

- ✔ Optional for UX Super
- ✔ Optional for UX 11200



Underbelly covers



Hydro-pneumatic axle suspension with AutoTrail axle steering



AutoTrail axle steering

# Steering systems for every application

Always remain on track!



✔ AutoTrail axle steering

❗ “When the wheels are turned in the field, hardly any steering forces are transferred to the booms. Therefore the steering is continuously active in the field – even in straight wheel tracks. Then if the tractor steers, the wheels of the sprayer are immediately also steered. How smoothly this happens we were able to see during operation. It didn’t matter whether we drove fast or slowly, nothing wobbled on the boom when turning.”

(“dlz agrar magazine” – Test report “Safe on the road” · 06/2011)

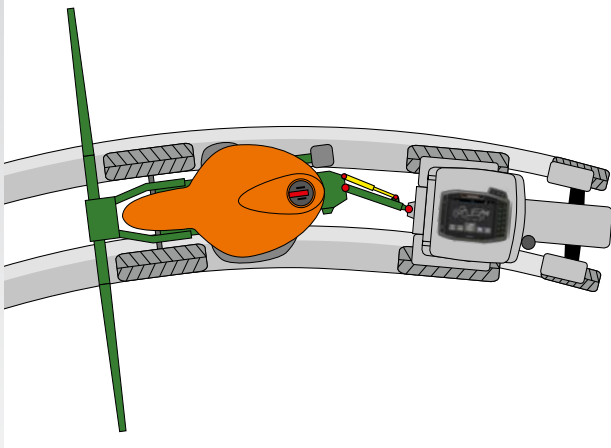

UX with AutoTrail drawbar steering in field operation

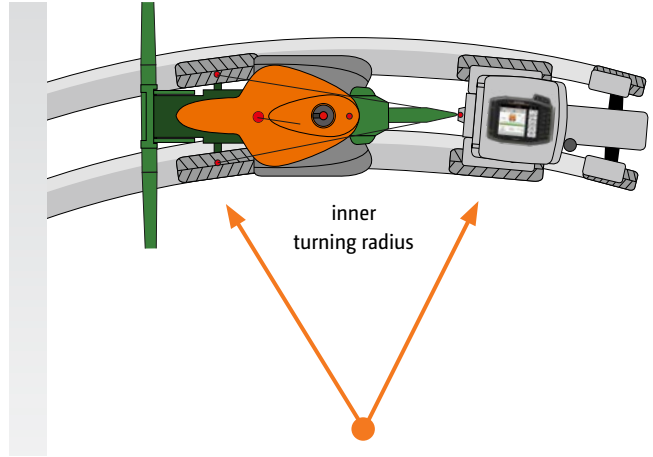

AutoTrail axle steering with rigid straight drawbar or rigid hitch drawbar in the field.

## AutoTrail drawbar steering

For the UX Special, in working widths up to 28 m, there is the option of AutoTrail drawbar steering when working on level ground. Alternatively, for the steering drawbar, there is hydraulic drawbar control that is usable, for instance, when turning in row crops.

- ✔ Optional for UX Special up to 28 m boom widths

## AutoTrail axle steering

The AutoTrail axle steering provides the driver with the utmost comfort and ensures an especially smooth boom ride and high stability. The track-following capability, particularly when in the reversing position, is outstanding. This steering of the axle is also possible in the folded-in position.

- ✔ Optional for UX Special
- ✔ Optional for UX Super

## Clever AutoTrail steering

AutoTrail steering ensures an intelligent, track-true steering behaviour and can be easily calibrated for any tractor type. The AutoTrail steering systems can be activated at any time and can be oversteered using manual readjustment on slopes. Especially helpful in narrow field entrances is, with the AutoTrail steering, the ability to activate the steering even with the booms folded.

- ✔ Standard for all AutoTrail steering systems

## Slope compensation for AutoTrail steering

As an option, AutoTrail steering can be equipped with a tilt sensor for fully automatic slope compensation. This works both with AutoTrail axle steering and also with AutoTrail drawbar steering. As the steering angle, depending on severity of the terrain, has to be possibly adjusted, the intensity of the setting can be altered at any time via the joystick.

- ✔ Optional for UX Special
- ✔ Standard for UX Super



- ✔ With steering angles of 20° (UX Special) and 28° (UX Super), the steering axle options for the UX trailed sprayers master those tight bends excellently

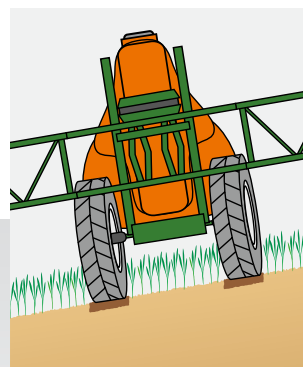

Activated slope compensation for AutoTrail steering

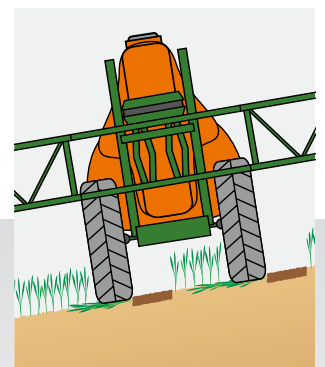

Slippage downhill with the slope compensation deactivated

# UX trailed sprayers

light – compact – manoeuvrable



## Low centre of gravity

The design of the UX tanks along with the compact AMAZONE booms ensure a low centre of gravity and very compact transport dimensions. In addition, the booms, even when folded, are optimally protected in transport via the sprung parallelogram boom frame.

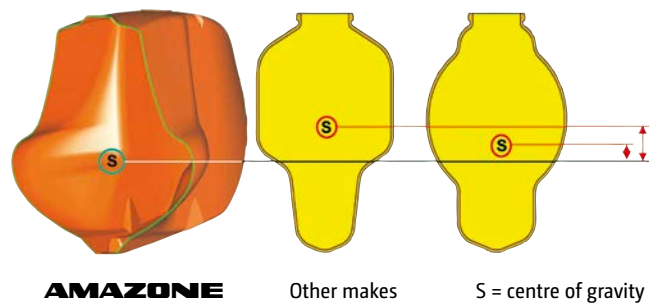



## Benefits of the tank design

- ✔ Easy cleaning of the spray agent tank
- ✔ Very low residual spray volumes
- ✔ Low transport height



## Tank – beautiful yet smart!

The compact spray agent tank, which is made from polyethylene, is especially secure, light and long lasting. The absolutely smooth inner and outer walls with rounded corners allow quick and easy cleaning. Residual spray volumes are kept at a minimum due to the specific shape of the tank sump.

## Cleaning systems

Three high-performance, rotating nozzles clean the spray agent tank internally. Short pipe runs and hose cross-sectional areas as small as possible make for low residual volumes.

## Exceptional internal sprayer cleaning with XtremeClean intensive cleaner

With XtremeClean AMAZONE offers a high-quality precise internal cleaning process for crop protection sprayers. The intensive cleaning system consists of four spot jet nozzles which have been fitted on to an electrically rotating nozzle head. These high-pressure nozzles are guided positively round via an electric motor and, via the spot jets, systematically treat the total internal wall area of the tank. The high impact energy of this jet reliably loosens the deposits – even without having to use chemical cleaning additives.

- ✔ Optional for UX Super

## Infinitely-adjustable, hydraulic main agitation

The intensity of the hydraulic agitation can, steplessly, be reduced down to nothing in order to avoid any foaming of the crop protection agent or to facilitate spraying out the remaining tank contents.

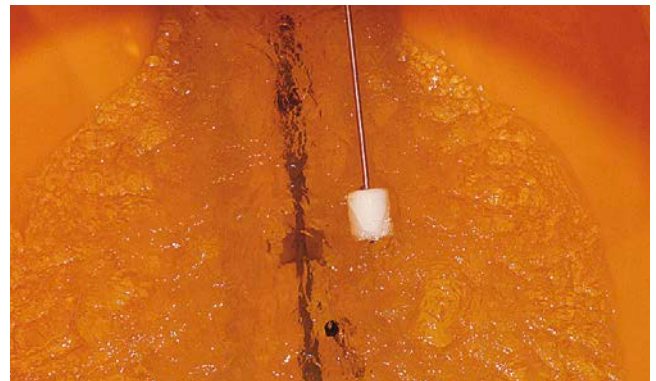

# The UX Special in detail

light – robust – reliable



❗ "Even on poor dirt tracks and when travelling fast on the road, we really did not have anything to criticise the driving behaviour of the UX 4200 about."

(*"dlz agrarmagazin"* – Test report "Safe in the track" · 06/2011)

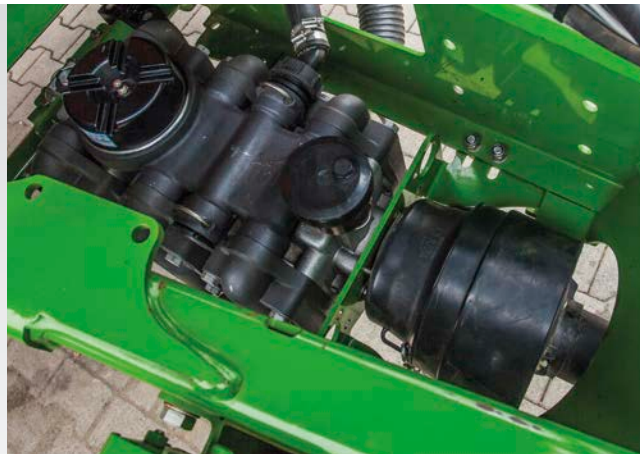

The UX Special can be equipped with pumps with a capacity of 260 l/min or 380 l/min.

## High performance and reliable single pump system

The UX Special features a single pump system with a capacity of 260 l/min or, as an alternative, 380 l/min. The pump is driven via the standard wide angle PTO shaft. During the filling procedure at a nominal pump speed, the full pump capacity is available for filling the spray agent tank. At the same time, either the contents of the induction bowl can be drawn out via the venturi or the total fill capacity can be increased up to 400 or 500 l/min.

### Benefits of the piston diaphragm pump:

- ✔ Simple handling due to its self-priming capability at the start of the filling procedure
- ✔ Very high, consistent application rates with system pressure up to 10 bar
- ✔ Can run dry and is liquid-fertiliser proof
- ✔ Long service life

## Induction bowl and power injector

The high-performance induction bowl features a volume of 55 l and ensures the safe induction of crop protection agents. Via the induction bowl, with its comprehensive rinse ring that includes an additional nozzle, powdery and granular spray agents are safely dissolved and at the same time quickly drawn in using the venturi. The induction bowl is splash-proof and can be, when closed, internally cleaned.

## Comfortable and thorough clean out with the induction bowl

For the comfortable cleaning of spray agent canisters and measuring jugs, the induction bowl provides a rotating nozzle. Thanks to this system, any sticky spray agents can be fully utilised and the canisters well rinsed.



The venturi fast fill on the UX Special allows filling speeds of up to 500 l/min.



The high capacity induction bowl ensures minimum fill times and a homogeneous spray agent mix

# SmartCenter of the UX Special

2" suction valve – suction capacity up to 500 l/min





UX Special Comfort-Pack

## SmartCenter – centralised operator station of the UX Special

All UX Special sprayers feature a centralised and ergonomically designed operator station, the SmartCenter. All operator controls are located in the front left hand corner, directly by the driver's cab door, and are logically and unmistakably marked. In addition for when filling, all UX Special sprayers feature manual external fill level indicators for the spray agent and fresh water tanks.

## Operationally safe suction and pressure filters

Both the suction and pressure filters are especially practical and operationally safe. The 32 mesh/cm<sup>2</sup> suction filter can be opened and cleaned even when the machine is full, without any loss of spray agent. The pressure filter on all UX sprayers is fitted, as standard, with either a 50 mesh/cm<sup>2</sup> or, as an option, 80 or 100 mesh/cm<sup>2</sup> inserts and is self-cleaning.



The suction filter can be opened and cleaned even with the sprayer full and without any loss of spray agent.



## Comfort-Pack – for the remote control of the spray agent system

Comfort-Pack on the UX Special controls the most important functions of the spray liquid system.

- ✔ Automatic fill stop
- ✔ Agitator control
- ✔ Automatic, in-cab remote cleaning

The hydraulic agitator is switched off at low fill levels to prevent any foaming of the crop protection agent and also to minimise the residual spray volumes when spraying. The remaining spray agent is always returned to the suction filter via the return flow. Thus, any unintentional dilution of the spray agent is avoided. The in-cab controlled internal cleaning nozzles ensure a superb cleaning efficiency. The Comfort-Pack automatically ensures that the agitation system is rinsed.



UX 5200 Special with Comfort-Pack and digital fill level indicator

# AmaSpray<sup>+</sup>

## Operator terminal for the UX Special

### Simple and versatile

AmaSpray<sup>+</sup> allows, as an alternative to the ISOBUS terminals, the simple, but still fully automatic regulation, of the UX Special trailed sprayers. The buttons, integrated in the operator terminal, enable the switching of 5, 7 or 9 part-width sections. AmaSpray<sup>+</sup> has digital pressure indication and digital tank level indication. It registers both, the quantity sprayed and the area worked. The actuation of the hydraulic functions though is carried out via the tractor control valves. AmaSpray<sup>+</sup> also visually indicates boom tilt and locking. As an option, AmaSpray<sup>+</sup> enables one sided folding of the boom or alternatively the access to the boundary and end nozzle spraying systems.

#### The benefits:

- ✔ Single, high-contrast, backlit screen
- ✔ Overall and part-width section control
- ✔ Up to 9 part-width sections
- ✔ Digital pressure indication
- ✔ Digital fill-level indicator
- ✔ Display of boom position and locking status
- ✔ Hectare counter (total and daily counter)
- ✔ +/- 10 % key
- ✔ Field record management system

#### Additional functions (with optional equipment):

- ✔ Pre-select fold for the independent boom folding
- ✔ End or boundary nozzle on/off control (alternatively to pre-select fold)
- ✔ Fold or tilt via 1 double acting control valve (electric changeover unit)
- ✔ ASD inside: serial interface

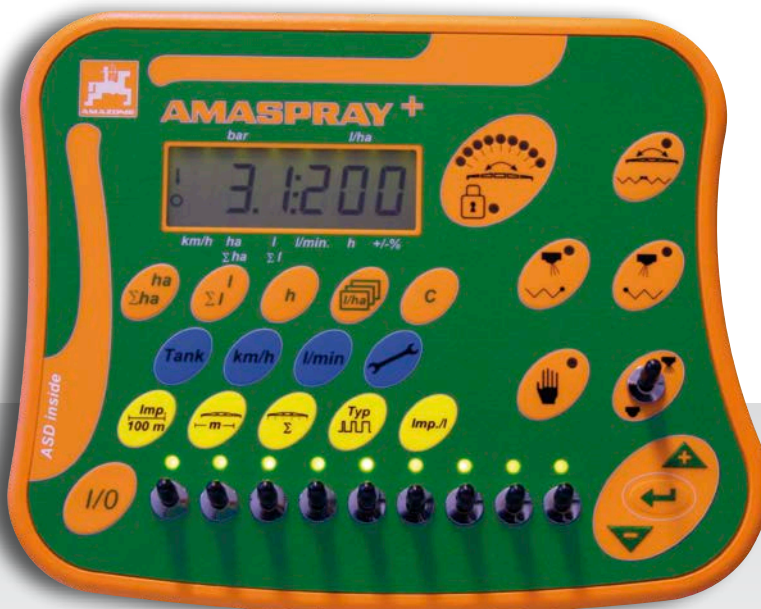

- ✔ With ISOBUS (see section on ISOBUS terminals) further operator terminals for controlling the sprayer are available

# ProfiClick

The small switchbox with a huge comfort factor



✔ ProfiClick mounts conveniently on the AmaSpray+

## The perfect supplement

The ProfiClick control box provides simple and precise control over the hydraulic booms and steering functions on the AMAZONE UX Special. The ProfiClick control box is available in combination with the electro-hydraulic Profi Fold 1. All the operational functions of the ProfiClick switch-box are ergonomically arranged and directly linked with a function. The potentiometer for the re-adjustment of boom tilt or for the automatic steering of a trailed sprayer can be controlled on the move without looking thanks to the centre position via a detent function. So the driver can concentrate perfectly on driving.

The ProfiClick control box, used for the actuation of the hydraulic functions of an AMAZONE sprayer, can be combined with the AmaSpray+ in-cab terminal, the AmaTron 3 operator terminal or with any other ISOBUS terminal. Thus it offers a favourable and comfortable control of the hydraulic functions via an oil circuit. On the tractor, only one single acting spool valve with a pressure-free return flow is required.



✔ ProfiClick switchbox without steering  
– Actuation of the boom functions via the oil circuit



✔ ProfiClick switchbox with steering  
– Actuation of the boom functions and the steering for true track following via the oil circuit

- ① Ergonomic hand support
- ② On/off
- ③ Boom pendulum lock
- ④ Boom fold
- ⑤ Boom up/down
- ⑥ Boom tilt

- ① Ergonomic hand support
- ② On/off
- ③ Steering automatic/manual
- ④ Manual steering
- ⑤ Boom pendulum lock
- ⑥ Boom fold
- ⑦ Boom up/down
- ⑧ Boom tilt

# The UX Super in detail

The precision machine. High performance and efficiency



UX 5201 Super trailed sprayer





The dual pump system on the UX Super masters delivery rates up to 520 l/min

### Dual pump system – High performance and reliability

All UX Super feature a low maintenance dual pump system with a capacity of 520 l/min. When spraying, one 260 l/min pump supplies the booms and the secondary agitation. The second pump, also with a capacity of 260 l/min, provides fill-level dependent, intensive agitation via the main agitator. As standard, drive of the dual pump system is carried out either via a wide angle PTO shaft or, as an option, via the hydraulic pump drive.

### High application rates thanks to HighFlow+

The UX Super's intelligent control technology enables both pumps to be used for spraying while maintaining a high agitation capacity. If the usual maximum of 200 l/min at the spray line is not enough, the liquid flow created by the agitator pump is also automatically used in conjunction with the HighFlow+ option as and when required until the desired application rate is reached. The remaining capacity of the agitator pump continues to be used for agitating the liquid in the spray agent tank.

HighFlow+ equipment pack with its second pressure filter, additional flow measurement device and changed liquid routing

- 1) second pressure filter
- 2) drain tap for pressure filter

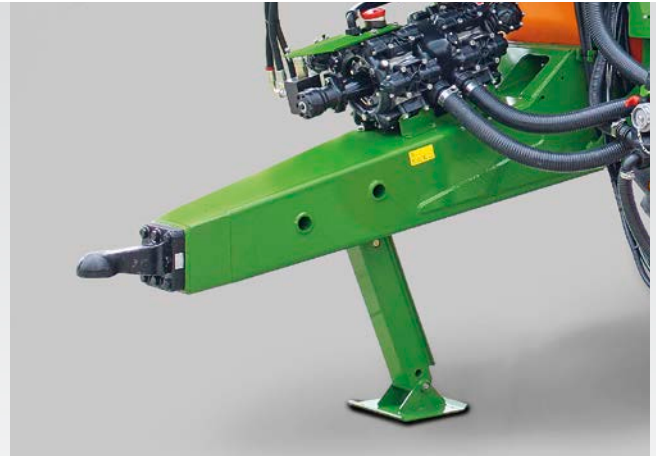

The hydraulic pump drive works independently of the engine revs at a constant, smooth speed.

During the filling procedure at a nominal pump speed, the full pump capacity is available for filling the spray agent tank. At the same time, either the contents of the induction bowl can be drawn out via the venturi or the total fill capacity can be increased up to 700 l/min.

#### Benefits of the piston diaphragm pump:

- ✔ Simple handling due to its self-priming capability at the start of the filling procedure
- ✔ Very high, consistent application rates with system pressure up to 10 bar
- ✔ Can run dry and are liquid-fertiliser proof
- ✔ Long service life

All components of the HighFlow+ system are completely integrated in the cleaning cycles of the UX 01 Super.



# SmartCenter: UX Super

The right technology for any application



✔ SmartCenter with Comfort-Pack plus and LED lighting, safely protected under the cover



### SmartCenter centralised operator station – including the induction bowl

In addition to the optical and practical differences, the UX Super trailed sprayer sets completely new technical standards. As a result of the SmartCenter, operation is easier and more comfortable than ever before. The SmartCenter, with its induction bowl and complete operator station together with the fill ports for suction and pressure filling, is located under the front left-hand cover.

### Any and every possibility

With its centralised SmartCenter operator station, the UX Super ensures that highly comfortable handling. No matter whether the SmartCenter is equipped with the Standard-Pack, Comfort-Pack or Comfort-Pack plus, filling and mixing with the UX Super is easily and comprehensively handled.

### More space. More order. More comfort.

The UX offers plenty of storage space and keeps things tidy with two dust-proof storage compartments on the left-hand side and a 240 litre lockable storage compartment with a removable intermediate shelf on the right-hand side.



240 l lockable storage locker on the right hand side



The high-capacity 60 l induction bowl

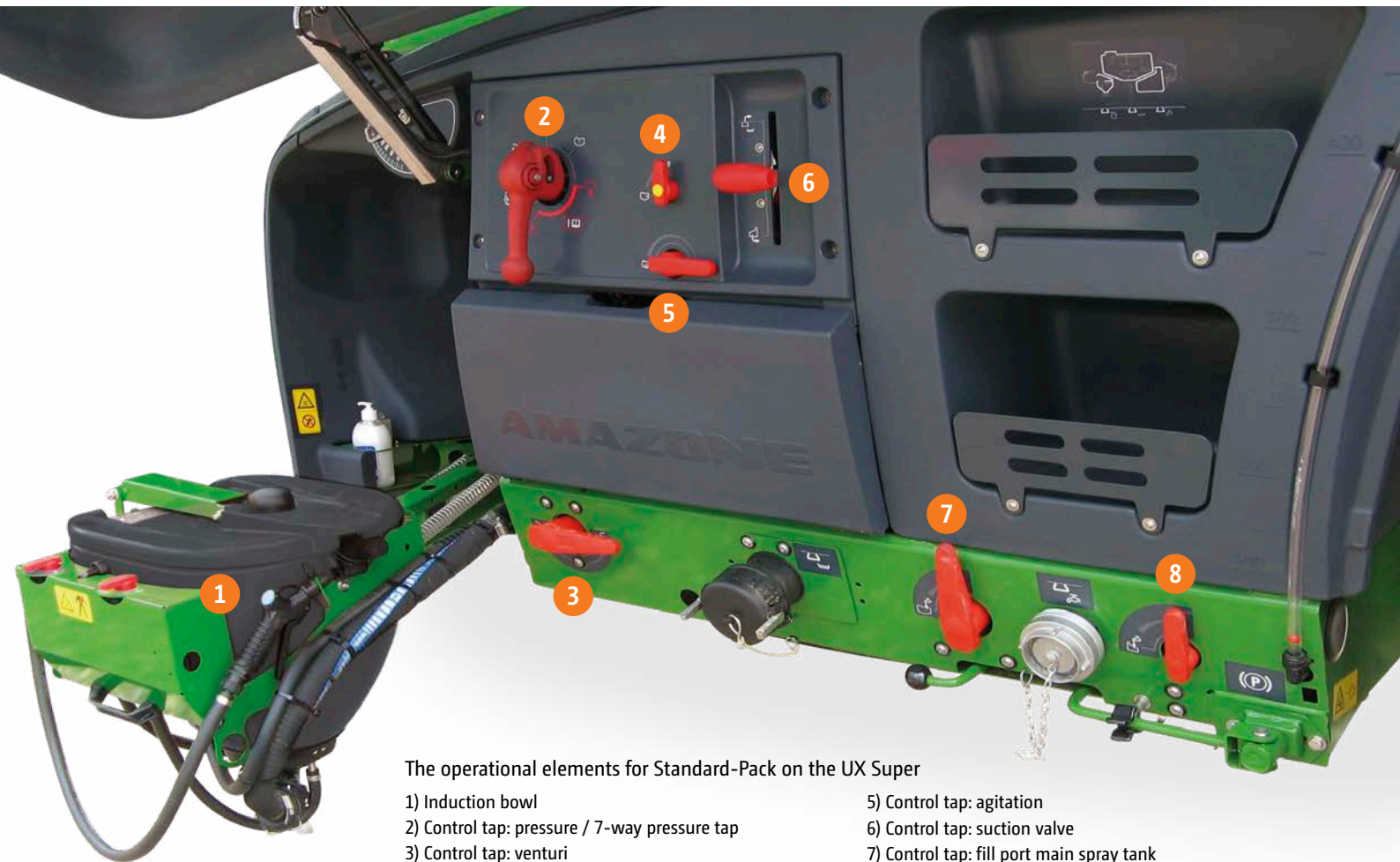

The operational elements for Standard-Pack on the UX Super

- |   |  |
|---|--|
| 1) Induction bowl                             | 5) Control tap: agitation                  |
| 2) Control tap: pressure / 7-way pressure tap | 6) Control tap: suction valve              |
| 3) Control tap: venturi                       | 7) Control tap: fill port main spray tank  |
| 4) Control tap: cleaning                      | 8) Control tap: fill port fresh water tank |

## SmartCenter with Standard-Pack – Simple and intuitive operation

With the Standard-Pack the operation of the UX Super is carried out mainly via a suction and a pressure tap. The suction tap indicates from where the pump is going to draw from and correspondingly, the pressure tap indicates as to where the spray liquid will be pushed.

### Your benefits:

- ✔ Simple access to the suction filter and to the self-cleaning pressure filter
- ✔ Self-explanatory, operator controls ensure safe handling
- ✔ Short fill times due to the high-capacity 60 l induction bowl with a draw-out capacity up to 200 l/min
- ✔ Homogeneous spray agent mixture thanks to the standard mixing nozzle in the bottom of the induction bowl
- ✔ The 7-way pressure tap with cam and seat valves technology provides simple operation and a reliable filling procedure



## 7-way pressure tap – safe switching with cam and seat valves

All sprayers with the Standard-Pack and Comfort-Pack are equipped with the particularly practical 7-way pressure valve. As opposed to a normal pressure tap, the in-house developed valve from AMAZONE consists of a cam and seat valves. Exclusively by swivelling in and out the handle on the pressure tap, the relevant liquid paths are reliably opened.



The operational elements for Comfort-Pack on the UX Super

- |   |                          |
|---|--------------------------|
| 1) Induction bowl                             | 4) TwinTerminal 3.0      |
| 2) Control tap: pressure / 7-way pressure tap | 5) Control tap: cleaning |
| 3) Control tap: venturi                       | 6) Display suction chest |

## SmartCenter with Comfort-Pack – actuation made easy

With the Comfort-Pack, the TwinTerminal 3.0 is also supplied as standard. In addition, the automatic fill stop for suction fill is made possible. As an option, fill stop is also available when force filling from a bowser. During the spraying operation, the agitator control regulates the agitation intensity in relation to the tank fill level. As the fill level decreases, the agitation intensity is automatically reduced down to nothing to prevent any formation of foam at low fill levels. In addition, the automatic agitation regulation offers auto-dynamic agitator control. This means: if a larger application rate is required at the boom, the agitation capacity automatically reduces.

After the spraying operation is finished, Comfort-Pack provides fully automatic cleaning which can be controlled completely remotely from the tractor cab. Additional functions such as boom rinsing, the cleaning the spray liquid circuit from heavy deposits or a defined dilution of a subsequent tank mix in the field are also included within Comfort-Pack.



TwinTerminal 3.0

### Your benefits:

- ✔ Operator-friendly TwinTerminal 3.0 for suction valve control
- ✔ No foaming of the spray agent due to the automatic, fill-level dependent control and switching off of the agitator
- ✔ Always maximum capacity when spraying and agitating thanks to the auto-dynamic agitator control
- ✔ Comfortable filling of the spray agent and fresh water tanks via the automatic fill stop
- ✔ Remote-controlled, automatic cleaning programmes for the complete sprayer wash-out

# SmartCenter with Comfort-Pack plus

Operation with maximum comfort on the UX Super



❗ "With very clear graphics for the tank, connections and liquid circuits, the operator is guided through the filling menus for the fresh water tank, spray agent tank and induction bowl – unique"  
 ("profi" - Test report Amazone UX 5201 Super - 10/2017)

❗ "Ingenious is– even with gloves (!) – the handling of the touch display."

("profi" - Test report Amazone UX 5201 Super - 10/2017)



## Operator terminal with pressure-sensitive touchscreen

Handling of the UX Super is made especially comfortable by Comfort-Pack plus. With Comfort-Pack plus, the operator terminal, with its touchscreen instead of the manual taps, eases the machine operation considerably. The complete control of the spray agent circuit is carried out solely via the pressure-sensitive touch screen which functions perfectly even when wearing gloves. The user just selects the desired function and the sprayer adjusts itself automatically! In the job computer, two individual filling profiles for different operators or applications can be stored. For filling then just the hose has to be coupled and the machine automatically fills the spray agent tank and fresh water rinse tank up to the desired tank fill level. As an option, the operator can select individually an adjustable pause in the filling of the spray agent tank.

## Fresh water pump – Continuous internal cleaning

In conjunction with Comfort-Pack plus and the load-sensing system, an optionally-available 160 l/min capacity fresh water pump is available, with which the induction bowl can be supplied with fresh water even when bowser filling under pressure. If a fresh water pump is specified, the fresh water

! "No matter, whether it's the pre-programmed 'fill profiles' or the automatic cleaning regime including the induction bowl – these things are unparalleled"

("profi" - Test report Amazone UX 5201 Super - 10/2017)

## Automatic and independent cleaning

The complete sprayer along with the induction bowl can be cleaned fully automatically. For this, the UX Super features, via Comfort-Pack plus, a variety of cleaning programmes: intensive clean, quick clean or just a simple rinsing out of the booms. In addition, after every filling procedure, the induction bowl can rinse itself on its own.

! "The press of a button starts the complete cleaning programme running where, not only are all the taps switched, but also the induction pipework and induction port are cleaned – very good!"

("profi" - Test report Amazone UX 5201 Super - 10/2017)

tank and the spray agent tank can be filled in parallel via the suction hose. The additional fresh water pump also allows the constant cleaning of the UX Super.

### Your benefits:

- ✔ Simple operation: choose the function and the machine adjusts everything fully automatically.
- ✔ Maximum comfort: automatic filling and automatic fill stop for when both suction and bowser filling
- ✔ Maximum safety: fully automatic cleaning of the entire machine including induction bowl
- ✔ Maximum capacity: automatic quick fill via the venturi when the chemical induction is completed
- ✔ Auto-dynamic agitation control

# SmartCenter

Possibilities for the UX Super at a glance



		Standard-Pack	Comfort-Pack	Comfort-Pack Plus
Operation: suction side	Manually-actuated		-	-
	Electrically-actuated via TwinTerminal 3.0	-		-
	Electrically-actuated via the pressure-sensitive Terminal 7.0	-	-	
Operation: pressure side	7-way pressure tap			-
	Electrically-actuated via the 7" pressure sensitive touchscreen terminal	-	-	
Bowser filling	- fresh water tank with Geka coupling			
	- with non-return valve			
	- free-flow return (from above into the tank with lid opened)			
	- automatic fill stop for the spray agent tank and the fresh water tank	-		
Functions: Suction valve	Drawing in via the suction port			
	- automatic fill stop for suction port			
	Drawing in via spray agent tank / fresh water tank			
	Dry coupling connection port			
Functions: Pressure valve	Filling the spray agent tank & drawing out of the induction bowl via the venturi			
	Liquid from the induction bowl (rinse ring, high-pressure nozzle, jet nozzle, hand lance)			
	Forced emptying			
	Internal cleaning			
	External cleaning with fresh water			
	Spraying			
	Filling of fresh water tank			
	- with automatic fill stop	-	-	
Additional functions	Automatic cleaning of the induction bowl	-	-	
	2 individually programmable filling profiles	-	-	
	Adjustable filling and foam damping function	-	-	
	Electric emptying of spray lines and filters	-	-	
	Capacity increase for canister cleaning	-	-	
	Rinse water pump	-	-	
Agitator	Manually-adjustable agitation level		-	-
	Fill-level dependent agitation level (automatic switching off at a fill level of approximately 5 %)	-		
Cleaning	Manually-actuated cleaning		-	-
	Remote cleaning control from the tractor terminal	-		
	XtremeClean	-		
Other	HighFlow <sup>+</sup>	-		

■ = included

■ = optional

- = not possible



✔ Standard-Pack



✔ Comfort-Pack



✔ Comfort-Pack plus



# The induction bowl

Perfect operational comfort with simple and centralised operation

## UX Super: High performing and efficient

The 60 l induction bowl is located directly in front of the operator station. The conical bowl shape, with its central outlet and the enormous suction capacity of up to 200 l/min, ensures the quick, trouble-free filling and its complete emptying. For inducting powders or granular spray agents, an additional mixing nozzle is positioned underneath the suction aperture which safely prevents any blockage of the suction aperture. This mixing nozzle can be steplessly adjusted for intensity and can be operated in parallel to the new, also steplessly-metered high capacity rinse ring. As a further advantage the induction bowl can, also when pressure filling from a bowser, be additionally supplied with fresh water via the optional rinse water pump.

❗ "Also other little details help during the cleaning procedure, such as the possibility to be able to flush the induction bowl with fresh water when pressure filling."

("profi" – Test report Amazone UX 5201 Super - 10/2017)



✔ The standard spray pistol is positioned on the right hand side of the induction bowl.

## Everything has been thought of

The canister cleaning nozzle features a spacious contact area with which the nozzle can be activated by just pressing down the canister or measuring jug. On the upper part of the canister cleaning nozzle, another small contact area is located where the nozzle for cleaning the canister neck can be activated. When opening, the dust and liquid proof lid on the induction bowl horizontally swivels over to the side where, in this position, it serves as a practical shelf which has holders for measuring jugs and inverted canisters. Thanks to the integrated run-off facility, any residual liquid is returned directly into the induction bowl. With the aid of the canister cleaning nozzle, a complete internal cleaning of the bowl can be carried out.

❗ "The robust lid not only serves as a storage area for the measuring jug or as a shelf for Bitter salt bags, but also features supports to enable the rinsed canisters to drain – exemplary"

("profi" – Test report Amazone UX 5201 Super - 10/2017)



# UX 11200 trailed sprayer

Triple pump system  
with a capacity of

## 750 l/min



## Super-L2

sprayer boom in lightweight design  
in boom widths of

## 24 to 40 m



### The advantages at a glance:

- ⊕ Outstanding driving comfort via the hydro-pneumatic suspended chassis with fill-level control
- ⊕ Optimum handling on the road with either the Single Trail track following steering or exact, track-true following with the fully automatic DoubleTrail axle steering
- ⊕ Ability to increase the support load on to the tractor via the integrated traction control
- ⊕ Large storage compartments on the left and right hand side of the sprayer
- ⊕ Simple and comfortable filling and cleaning via the standard Comfort-Pack
- ⊕ High-performance induction bowl for minimum fill times and for a homogeneous spray agent mixture
- ⊕ High-capacity, self-priming, low maintenance piston diaphragm pumps for large application rates even at high spray pressures
- ⊕ DistanceControl fully automatic boom guidance
- ⊕ DUS or DUS pro pressure recirculation systems for continuous recirculation of the spray agent
- ⊕ 50 cm part-width sections and optimum nozzle choice thanks to the electric AmaSwitch and AmaSelect individual nozzle controls
- ⊕ Automatic cleaning programmes for perfect results

Spray liquid tank with  
**11,200 litres**



## DistanceControl / DistanceControl plus

Boom guidance with 2 or 4 sensors

UX 11200 Super  
with 36 m Super-L2 boom

The UX 11200 trailed sprayer, with its enormous tank volume of 11,200 litres, can cope easily with the high pressure to cover the acres. With the Super-L2 sprayer booms in working widths of 24 to 40 m and its triple pump system with suction capacity of up to 900 l/min, it is perfectly suited to large area farming or crops that require particularly high application rates.



**MORE INFORMATION**  
[www.amazone.net/ux11200](http://www.amazone.net/ux11200)

# The UX 11200 in detail

A new dimension in crop protection technology



- ✔ Fast on the road at up to 60 km/h  
Perfect driving comfort due to level regulated,  
hydro-pneumatic axle suspension.



## Chassis design at its finest High performance in the field and on the road

In conjunction with the sprung suspended hitch drawbar, the hydro-pneumatic chassis provides perfect driving comfort. The BPW axles with level regulation as standard permanently adapt to the load status. Possible track widths of between 2.00 to 2.25 m, wheel diameter up to 1.95 m. Thanks to its high support load of 3 tons, the hitch drawbar in conjunction with the K80 ball hitch makes sure there is good traction for the tractor and a smooth running of the machine. The crossover linkage of the suspension cylinders provides a high roll stabilisation for the machine. The enclosed hydraulic system ensures always an equal load distribution to all 4 wheels.

## Large tank: sleek and functional

The spray agent tank features a low centre of gravity and compact dimensions. Due to the optimised geometry, residual spray volumes of less than 20 litres are left when empty. The smooth inner walls of the tank allow the quick and easy cleaning.

The two fresh water tanks, with a nominal capacity of 900 litres in total, are located, centre of gravity neutral, between the mudguards.

All the controls are conveniently located at the front under a cover. The cover prevents the operator station from becoming dirty and offers a very good accessibility for quick and effective maintenance.

## Traction compensator

The UX 11200 also excels on heavily sloping ground: the traction compensator in the hydro-pneumatic axle suspension enables a temporary increase of the drawbar support load from 3 to 4 t with a filled machine. When the machine is partly filled, the support load increases by up to 30 %. This is possible due to a setting valve in the hydraulic system which controls the level of pressure in the suspension of both axles.

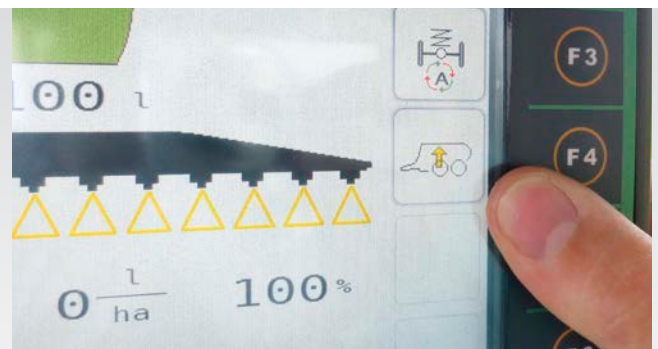

# Optimised driving behaviour

Perfect steering on the UX 11200



## ✔ DoubleTrail axle-steering

- active electronic-guided steering
- excellent track-following with little crop damage in the field
- easy manoeuvrability due to the active, intelligent rear axle
- always a uniquely smooth boom performance



### SingleTrail self-steering

As standard, the chassis of the UX 11200 features a trailing steered rear axle for a good driving behaviour and minimal crop damage. For the SingleTrail self-steering system, the front axle is rigid and the second one steered and follows passively, resulting in a very good driving behaviour without “scrubbing” the tyres.

When reversing, the second axle has to be locked. In road transport it should also be locked as well. In tight turns and slow travel, the axle can be unlocked.

### DoubleTrail – fully automatic axle steering

Optionally, the UX 11200 can also be equipped with the electronically-controlled DoubleTrail axle steering. This positive, electronic steering of both axles is of special importance for row crops, such as potatoes, sugar beet or in small fields to prevent track damage.

The first axle now truly follows the tracks of the tractor’s rear wheels; the second axle follows the track of the tractor’s front wheels. In this way the tracking performance perfectly matches the tractor and, above all, the sprayer boom ride is unaffected by any steering movements. In road transport, the first axle is locked and the second one is actively steered by the system.

- ✔ DoubleTrail system  
For the forced steering of the DoubleTrail-system an additional K50 ball is required.

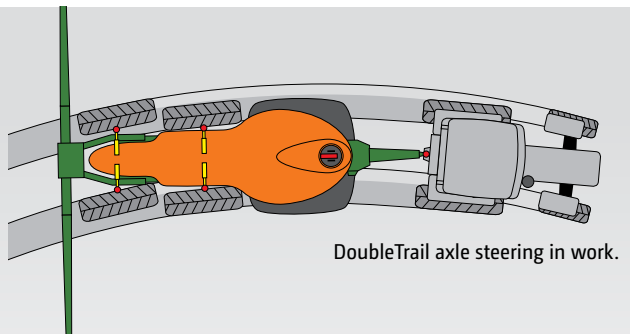
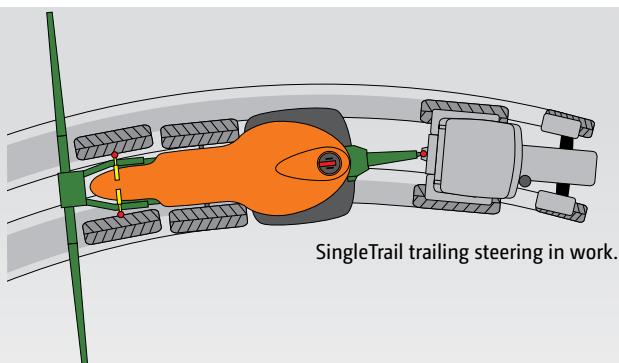

# SmartCenter: UX 11200

Centralised operator station and high-capacity pump



## Clearly identifiable controls for the UX 11200:

- |   |  |
|---|--|
| 1) Digital fill-level indicator                           | 7) Comfort-Pack  |
| 2) Pressure tap   | 8) Suction tap   |
| 3) Pressure filter  | 9) 4" suction port   |
| 4) Suction filter   | 10) Injector switchover  |
| 5) Agitation tap with integrated pressure filter emptying | 11) Ecomatic suction coupling (option)   |
| 6) Ecomatic rinse foot (option)                           | 12) 3" fill port with camlock coupling for the fresh water and spray liquid tank |





## Exceptionally simple, central operation via the SmartCenter

All the controls are conveniently located at the front under a cover. The cover prevents the operator station from becoming dirty and offers a very good accessibility for quick and effective maintenance. The LED lighting keeps the work area perfectly illuminated.

## Intelligent, hydraulic pump drive

For the pump drive, boom hydraulics and the DoubleTrail steering, with the proviso that a Load-Sensing system is necessary on the tractor, all the functions can be operated especially comfortably via an ISOBUS terminal. The positive benefit also is the automatic setting of the pump speed with regard to each operational situation. When operating in the field, the pump runs at a gentle 480 rpm; sufficient capacity for the agitation and normal application rates. Whilst travelling on the road, the pump speed is automatically reduced to 400 rpm as the only demand is for a supply to the agitation. When filling via the suction hose, then the full pump capacity is provided by increasing the speed to 540 rpm. All the values are pre-selected once by the user but it is also possible to change them at any time. The system relieves the stress on the operator and provides a particularly sensitive connection to the pump and the diaphragms.

## High-capacity pumps – three times over as well

The multi-cylinder equipped piston diaphragm pumps provide at the same time a higher suction capacity for the injector via the 4" suction port (900 l/min) and hence a more even transfer and a smoother run of the pump. The three compact pumps, with a total output of 750 l/min, have an extremely long lifespan, will run dry and are also liquid fertiliser-proof. An additional practical advantage is its maintenance-friendly position and easy accessibility on the drawbar. Changing the diaphragms is possible without dismounting the pumps.

## HighFlow – brings new performance dimensions

To double the maximum application rate, the UX 11200 pumps can be switched in parallel. The HighFlow option opens up a new dimension in output.

- ✔ It allows large quantities of liquid fertiliser to be applied at higher speeds.
- ✔ For vegetable growing, spray rates of 2000 l/ha at 5 to 6 km/h are possible.
- ✔ These large amounts are possible by utilising the TG valve chest equipped with an additional spray line and a double nozzle layout on a spacing of 25 cm or with AmaSelect.



# 1,032 hectares in 24 hours



## AMAZONE sets the world record in crop protection

*Is it possible to cover an area of 1,000 ha with a crop protection application within 24 hours? This question can be now answered with an emphatic Yes: Registering 1,032 ha of treated area in just 24 hours, the UX 11200 plant protection sprayer set the world record in 2014.*

Converted into an average work rate, the UX 11200 – at 43 ha per hour – also set a second new record for output from today's modern crop protection technology. With its tank capacity of 12,000 l and tandem axle running gear, the UX 11200 is currently the biggest trailed sprayer in the AMAZONE range. Equipped with a 40 m wide Super-L2 boom and pulled behind a 330 HP Fendt tractor during the world-record attempt the sprayer was operated, depending on the weather- and field conditions, at daytime speeds of 13 to 15 km/h and during the night – thanks to the absence of wind and dew formation on the plants, of 17 km/h. The sprayer was filled directly in the field from a 21 m<sup>3</sup> l water bowser along with a 1,000 l crop protection agent bulk container on the load platform of the towing vehicle.

The world-record operation, which was projected to last exactly 24 hours, started on September 3rd, 2014 at 12 o'clock at Golzow farm near the village of Golzow in Brandenburg. The farm covers, in total, an area of 6,490 ha and is representative of European crop protection conditions in practice and thus shows where the UX 11200 can fully demonstrate its strengths.

The actual treatment programme was, following on from harvesting rape the spraying of volunteer rape with glyphosate at an application rate of 100 l/ha of water across 15 different fields. The treatment was carried out with the full agreement of the farm's crop protection manager.

### Almost 30% of non-productive time

The statistics created in the course of the world-record attempt, showed emphatically the effect of field size and shape on actual work rates: for field sizes between 40 and 124 ha and tramline lengths of approx. 0.5 to 1.5 km, this value ranged between 38 ha/h on the most unfavourable and 45 ha/h in the best fields. This represents a difference of 18% in the area covered.

Even more noticeable was the importance of unavoidable non-productive periods. Compared with a theoretical acreage output of 60 ha/hour, there is a non-productive differential of 28%. Thanks to the large tank capacity of the UX 11200, only 8% of the non-productive times are related to the sprayer filling process. So, despite the total of 103,200 litres of spray liquid applied, the sprayer had to be refilled only 10 times during the world record attempt.

Moving the sprayer between the different fields lost nearly 1.5 hours and thus approximately 6% of the non-productive time. For this the sprayer and tractor combination had to cover, in total, a distance of almost 20 km. Finally, the majority of non-productive time was attributed to driving around pylons and irrigation points and turning on the 40 m wide headland. Despite the favourable field structure, this required a time expenditure of 3.5 hours in total and thus almost 15% of the overall non-productive time.





Bernd Ullrich, Agrargenossenschaft Bad Dürrenberg

### More efficiency, less logistics costs

“This investment was worthwhile“ Bernd Ullrich, manager of the Agrargenossenschaft Bad Dürrenberg, reports on operating an UX 11200. The agricultural co-operative farms 4,600 ha of arable land and 400 ha of grassland in the Leipzig lowland area.

The specification of the UX 11200, which is pulled by a 230 HP tractor, includes a 24 m Super-L2 boom with LED lighting, DoubleTrail axle steering system and GPS-Switch, the automatic headland and part-width section control. “The decisive benefit of the UX 11200 clearly is the large tank – and in this way a huge increase in efficiency“ manager Bernd Ullrich says. At water rates of between 200 and 300 litres/ha, now between 40 and 60 ha can be sprayed without the need of a filling stop.

In spite of the large tank capacity of the UX 11200, the ground pressure has not been increased and also wheel track damage is no problem. Bernd Ullrich explains this by the tandem axle and the DoubleTrail axle steering. “With this steering, the wheels in fact still follow in exactly the tractor track. This saves the soil and, of course, also has an effect on the boom ride.” On the other hand the driving behaviour of the sprayer at fast road speeds and with a completely full tank is also very positive. Absolutely recommended is, according to Bernd Ullrich, the LED lighting of the sprayer boom and GPS-Switch. “In this way we are able, if necessary, to operate the machine also at dawn or dusk.”



Andrey Alexandrovich Novikov, KX Novikov

### Efficiency that impresses: 700 ha/day

On the 5,000 ha “ KX Novikov“ farm in Krestyanka/Russia, a UX 11200 has been operated since 2013. “The huge capacity of 12,000 litres“ owner Andrey Alexandrovich Novikov indicates as the most important reason for this investment. Also the AmaTron 3 operator terminal impressed him. The specification of the UX 11200 includes a 36 m Super-L2 boom with Profi-fold 1 and the automatic DistanceControl boom guidance. The chassis is equipped with the Single-Trail self-steering rear axle.

Instantly the UX impressed with its efficiency. With water rates in the region of 100 l/ha and depending on the soil conditions, the operating speed of the 335 HP tractor, with GPS control, varied between 11 and 19 km/h, the average speed being 14 km/h. On the other hand, the fuel consumption of only 0.3 to 0.4 l /ha of diesel was very low. Due to mostly short farm-field distances, the sprayer is filled at the farm; however, when travelling longer distances, filling is from the field edge via a water bowser. Due to the large capacity potential of the UX 11200 Andrey Alexandrovich Novikov intends to use also larger volumes of water in the future, in this way 700 ha/day could be managed in a 2-shift system at 200 l/ha.

 **AMAZONE output calculator**  
 Calculate your own mechanisation scenarios at:  
[www.amazone.de/leistungsrechner](http://www.amazone.de/leistungsrechner)



# UX booms: aircraft wing design

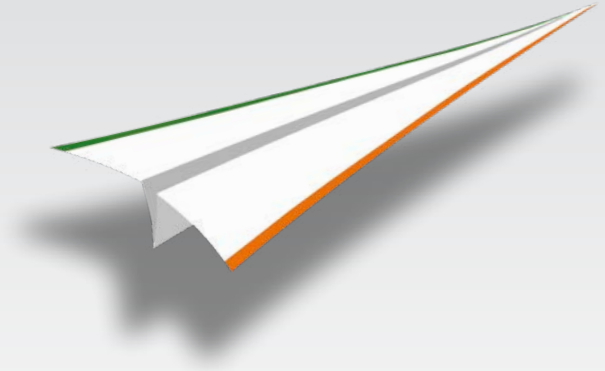

## Simultaneously superbly robust and superbly light

Thanks to the special profile design AMAZONE booms are at the same time superbly light and superbly strong. The boom working widths from 15 to 40 metres allow the optimised matching of the sprayer to the structure of the farm. High-grade quality ensures a long operational life even over very high acreages.

The compact transport dimensions with transport widths of 2.40 m to 2.85 m also contribute to the safe transport on the road.



## AMAZONE booms

Sprung damping of the boom during transport



✔ Everything shipshape: The boom is located safely without movement in its transport position. The parallelogram suspension dampens shock loads in the field as well as in the transport position. This is pure convenience and, above all, ensures the long service life of the boom.

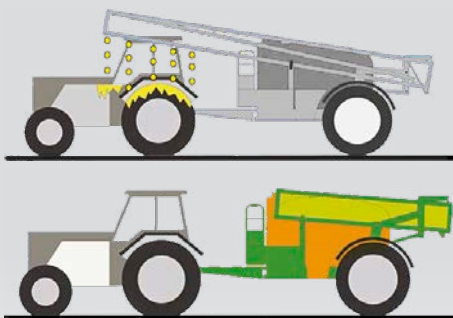

✔ No spray agent from the booms drips on to the tractor. The booms also do not hit the tractor cab.



✔ Focussing on the substance: the road in front of you  
You can concentrate entirely on driving. The visibility in road transport is exemplary. Where the tractor can get through then the trailed sprayer can also pass. No protruding parts, no boom damage. 50 km/h no problem!

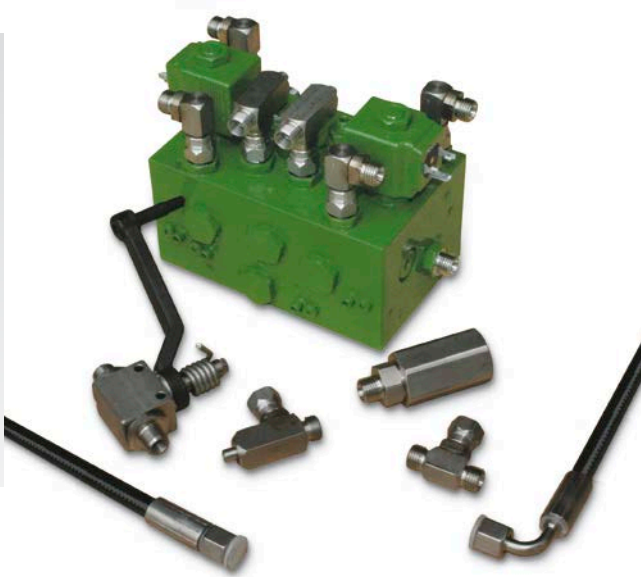

✔ The hydraulic fittings are made from high-grade steel for a longer service life and an improved resale value.

### Maintenance-free and with a long service life

The decades of experience in boom design pay off: The conical hinge pin is the intelligent centre of a well thought-out boom philosophy! The boom pivots self-adjust against any play on the conical hinge pins and that ensures for the user an optimised boom function even after many years.

The standard use of stainless steel, the automotive-industry standard, cathodic dip painting process and the targeted use of plastics and aluminium are the perfect guarantee of a long service life.

### High-quality, multi-layer paint

The high-quality, multi-layer paint finish ensures that top, long-lasting quality

- 1) sheet steel
- 2) zinc phosphate (galvanising layer)
- 3) KTL priming coat
- 4) top coat

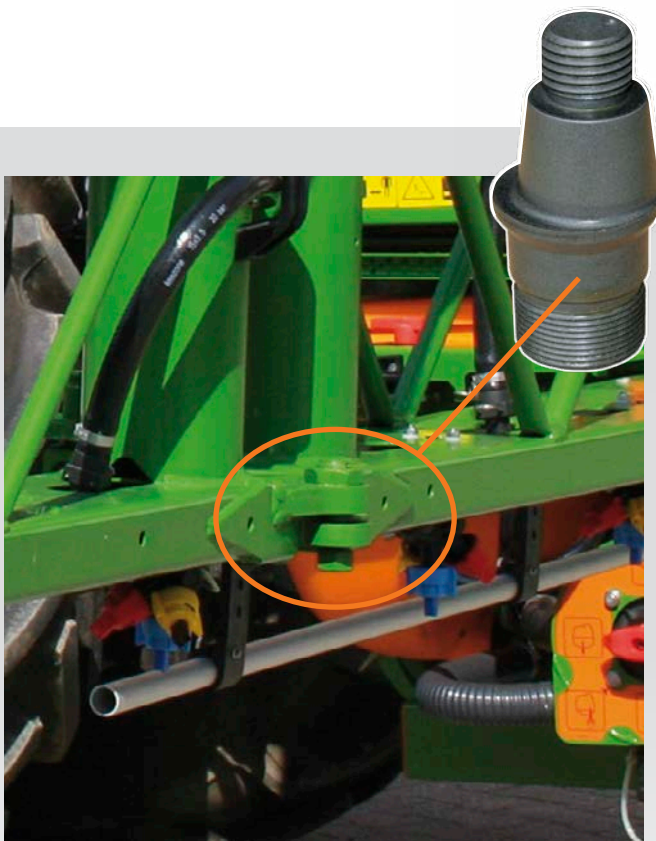
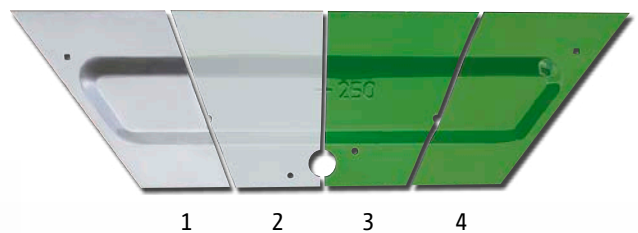

✔ A pivot joint that lasts!



✔ The stable, spacious platform ensures good, safe access

# Super-S2 booms

For the UX Special

## Superbly compact on the road

Superbly narrow transport width of just 2.40 m on all Super-S2 booms: 15 – 18 – 20 – 21 – 24 – 27 – 28 m.

The Super-S2 boom folds fully automatically, in or out, via oversized hydraulic rams. In the transport position, the boom sits compactly behind the tank with a transport width of only 2.40 m.

The multiple-folded steel profiles of up to 140 mm wide make the Super-S2 boom extremely robust.

## Three important elements for excellent boom guidance

Super-S2 booms come as standard with:

- ✔ central pendulum suspension for the optimum boom guidance on slopes and on level ground,
- ✔ combined spring and damping elements for shock-dampening the suspension against vertical forces,
- ✔ integrated damping system consisting of braking plates and buffer blocks to damp down the horizontal yaw movement.

Due to the shock-absorbing suspension provided by the hydraulic accumulator in the parallelogram frame, the Super-S2 booms are reliably maintained at the right height above the target surface.

## Super-S2 boom suspension

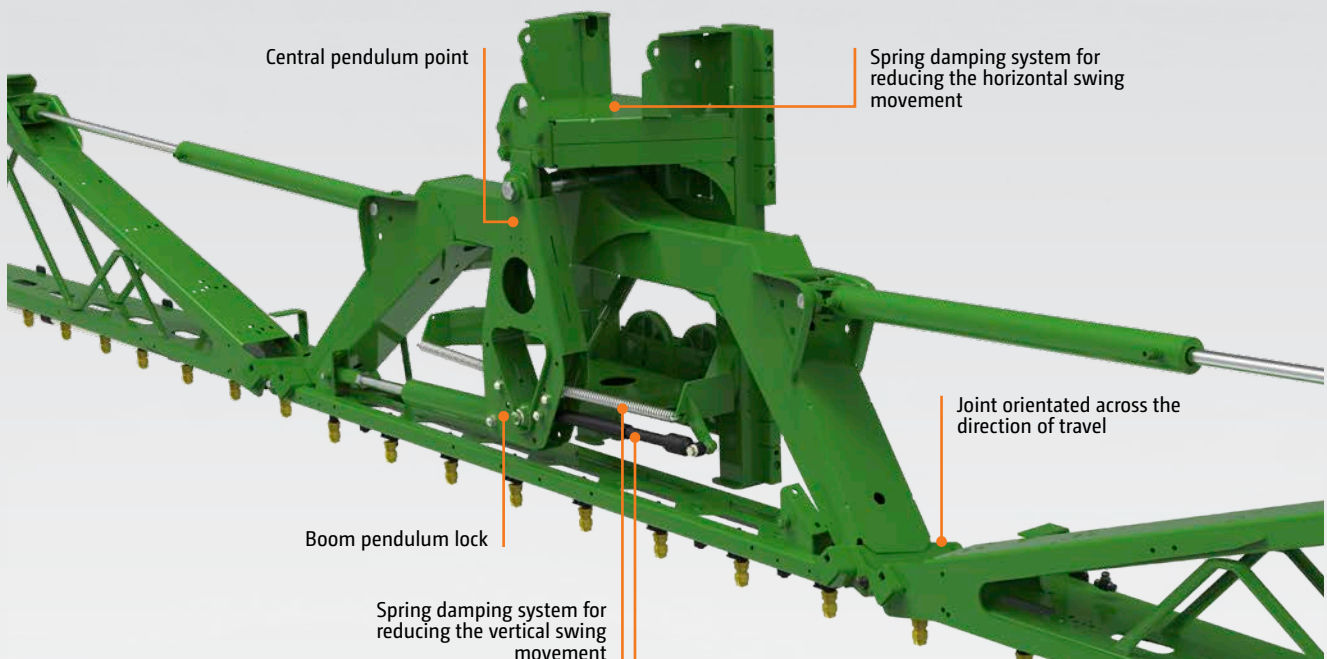



UX 4200 Special

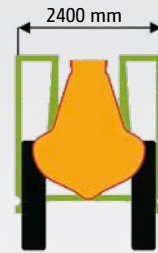

In transport position

## AMAZONE booms – an idea gets its way

### Drive safely!

The visibility in road transport is exemplary. Anywhere the tractor can go, the sprayer with its narrow booms goes as well. No protruding parts, no boom damage, minimal transport width.

### Everything shipshape!

The boom locates safely in the transport hooks. No rattling, no wear susceptible boom that rests on the tractor. Travelling fast is not a problem.

### Clean working!

No spray agent from the booms drips on to the tractor or on the operator station and the booms also do not hit the tractor cab.

## Potential folding widths of the Super-S2 boom

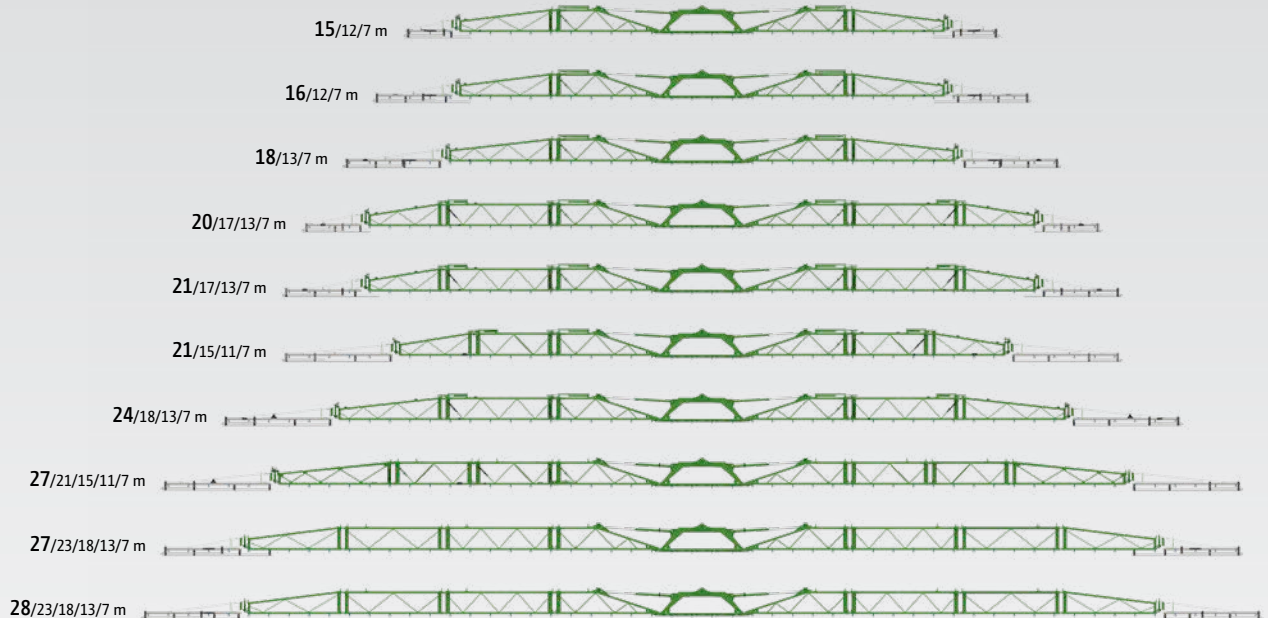

# Super-L booms

super-stable, super-light and super-compact







UX 5201 Super with Super-L2 booms



UX 11200 with Super-L2 booms

## The 4-fold damped Super-L booms – Smooth-travelling and exact as standard

Boom guidance of the Super-L boom is optimised by the central pendulum suspension. In addition, the combined spring and damping elements provide an enormous reduction in any potential vertical movement. Also the horizontal pivoting movements are kept at a minimum by the integrated damping system so that, for all AMAZONE booms, optimum work results are achieved.

### The benefits:

- ✔ a particularly long central pendulum system means parallel guidance of very wide booms
- ✔ combined spring and damping elements for shock-dampening the suspension against vertical forces,
- ✔ integrated damping system consisting of braking plates and buffer blocks to damp down the horizontal yaw movement.
- ✔ leaf springs absorb the movements in the driving direction (from 39 m boom width)

## Super-L boom suspension

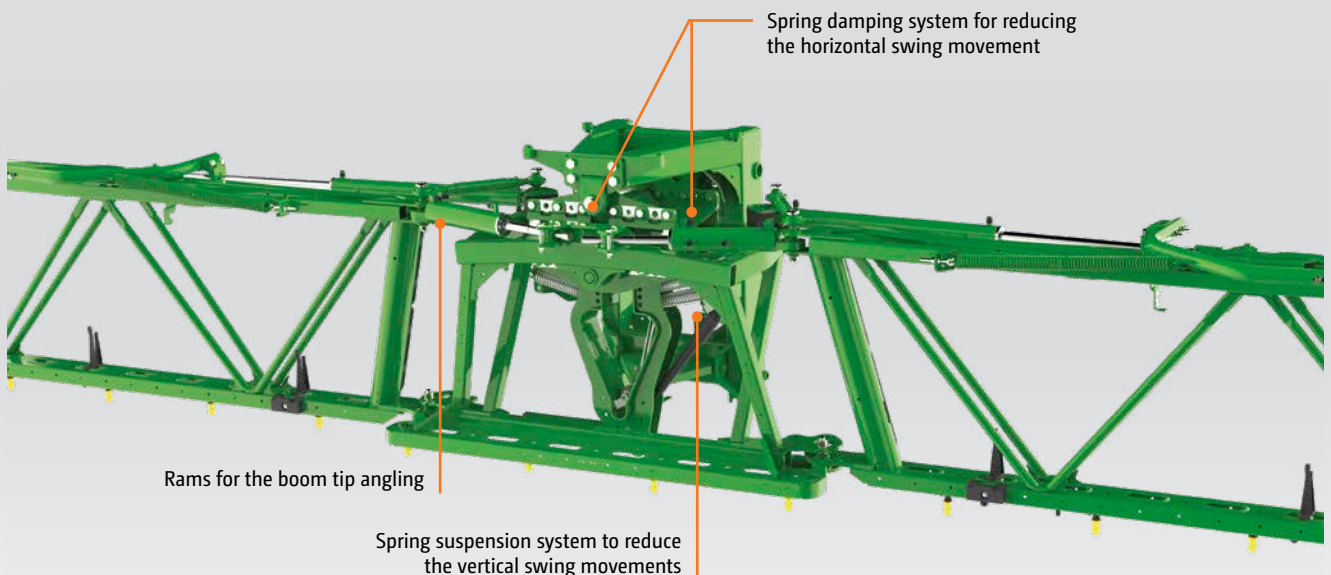



39 m Super-L2 boom

## Super-L2 boom in working widths from 21 to 40 metres

Superbly narrow transport width of just 2.40 m on all three-fold Super-L2 booms with working widths of 21, 24, 27 and 28 m. Amazing transport width of only 2.60 m on all four-fold Super-L2 booms with working widths of 27, 28, 30, 32, 33, 36, 39 and 40 m (UX 6200: 2.80m).

## Potential folding widths of the Super-L2 boom

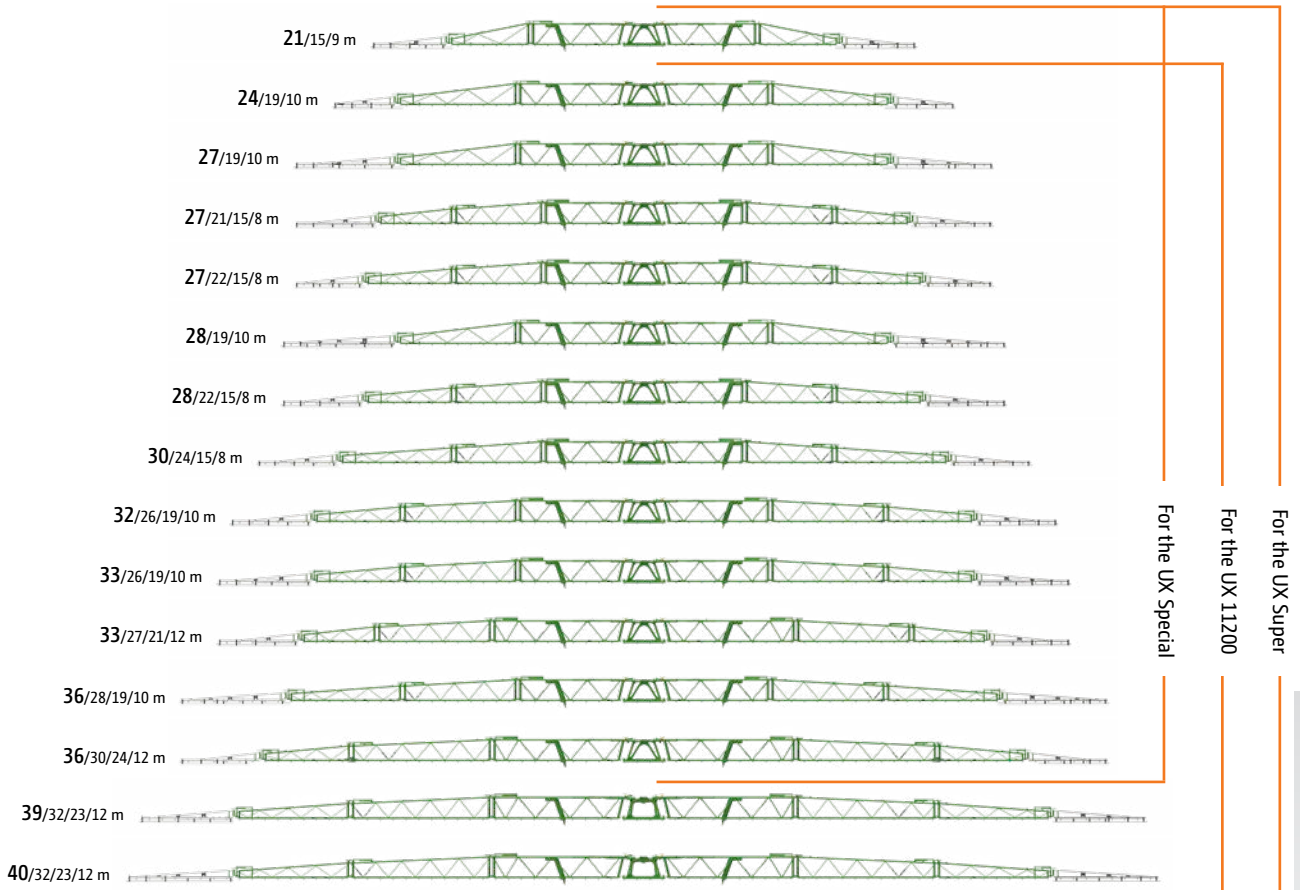



36 m Super-L3 boom, usable at both 24 m and 12 m as well

## Super-L3 boom in 36 m working width

The Super-L3 boom supplements the 36 m working width Super-L2. The outer and middle boom sections each have a length of 6 m, so that the Super-L3 boom is made up of only 3 sections each side. This makes it possible to use the 36 m Super-L3 boom also at a reduced working width of either 24 m or 12 m. The end boom sections come fully constructed in aluminium with additional bracing bars. This ensures very high robustness yet with a very low weight. As standard, the hydraulically pressurised break back system on the boom end can evade obstacles from the back, front or from the top. The advantage of the hydraulically pressurised break back, that works similar to the saloon door principle, lies in the constant release forces across the whole protected area. It furthermore guarantees return back to the working position under all conditions with the minimum of wear.



Hydraulically pre-tensioned break back joint at the boom end which works on a saloon door principle



# The outstanding made easy – folding options from AMAZONE

## Pre-select folding

One-sided boom folding is possible through either an AmaSpray+ or ISOBUS terminal using the tractor spool valves.

The high level of flexibility offered by the pre-select folding function enables each boom section to be folded individually. No matter whether left and right hand or both sides

can be independently and individually folded to match to any situation in the field.

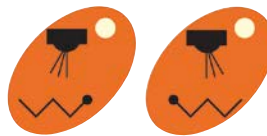

## Profi-fold 1

All the hydraulic functions can be carried out safely and simply via the ISOBUS terminal in the tractor cab. The multi-function joystick makes handling especially comfortable.

### The following functions are possible:

Height adjustment, fold out and in, independent one-sided folding at a reduced forward speed (max. 6 km/h), boom width reduction, tilt adjustment.



Independent fold

## Profi-fold 2

In addition to the functions of Profi-fold 1, Profi-fold 2 enables both independent folding and individual angling of the boom tips.

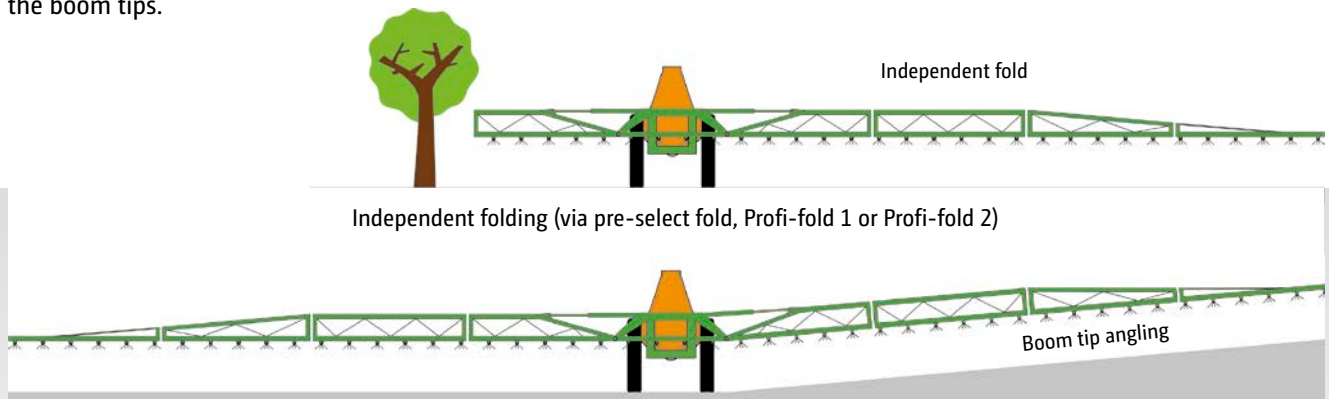

Independent folding (via pre-select fold, Profi-fold 1 or Profi-fold 2)

Boom tip angling (via Profi-fold 2)



Flex-fold 2 with ContourControl provides the optimum boom guidance

## Flex-folding for the UX Super

AMAZONE offers two electro-hydraulically boom folding options, Flex-fold 1 and Flex-fold 2. Each boom folding joint is equipped with an electro-hydraulic valve block that is directly controlled by the machine software. This enables faster folding procedures. As soon as the first boom section is folded in or out by approximately 70%, the next section automatically starts to fold in or out.

## Individual user profiles for reduced working widths

Via the user profiles in the machine software, individual profiles that recognise a reduced working width can be stored. If, for instance, it is intended to fold out a 36/30/24 m boom to just 30 m, this can be carried out quickly and simply via a profile change. After folding out just the relevant sections, the active working width is automatically detected and the outer nozzles are automatically deactivated via AmaSwitch or AmaSelect. For section control, the working width is automatically stored.

## Flex-folding 1

In addition to the benefits already outlined, Flex-fold 1 provides the following extra functions:

- ✔ Height adjustment,
- ✔ Folding in and out,
- ✔ Independent fold at reduced forward speeds (max. 6 km/h),
- ✔ Boom width reduction,
- ✔ Tilt adjustment

## Flex-folding 2

In addition to the advantages mentioned previously, Flex-fold 2 offers the following functions:

- ✔ Positive boom angling of individual / both sides
- ✔ Negative boom angling of individual / both sides

- ❗ "To speed up the folding procedure, AMAZONE has replaced the simple sequence control by a sensor controlled process. With this we clocked a quick 19 seconds for folding out and 27 seconds for folding in – great!"

("profi" – Test report Amazone UX 5201 Super - 10/2017)

# Automated boom height control

With maximum comfort and even more precision

## AutoLift, DistanceControl or ContourControl? Decide for yourself!

The AutoLift, DistanceControl and ContourControl automatic boom guidance systems offered by AMAZONE provide a suitable solution for every need. Just utilising the standard AutoLift already provides convenient assistance. The fully automated DistanceControl boom guidance leaves the boom control almost completely in the hands of the machine.

The innovative ContourControl boom control is AMAZONE's high-end solution, ideal for customers with difficult terrain conditions. In addition to fully automated height guidance, ContourControl also offers active vibration damping for the boom. Contour-Control satisfies the demand for higher accuracy, even at faster forward speeds.

### ✔ Automatic boom lowering in GPS-Switch

In GPS-Switch, the booms can be activated to start to already lower prior to reaching the untreated areas. This means that, when the nozzles open, the booms are already at the correct

working height. Requirements for this function are just a field boundary saved within the GPS-Switch in the AMAZONE ISOBUS terminal.

## AutoLift – the automatic comfortable headland system

AutoLift automatic boom lift (standard equipment) lifts the boom to the pre-selected height every time the machine is switched off. It lowers back down again to the target height

when the sprayer sections are switched on. This reduces the risk of damage to the boom while turning on the headland.

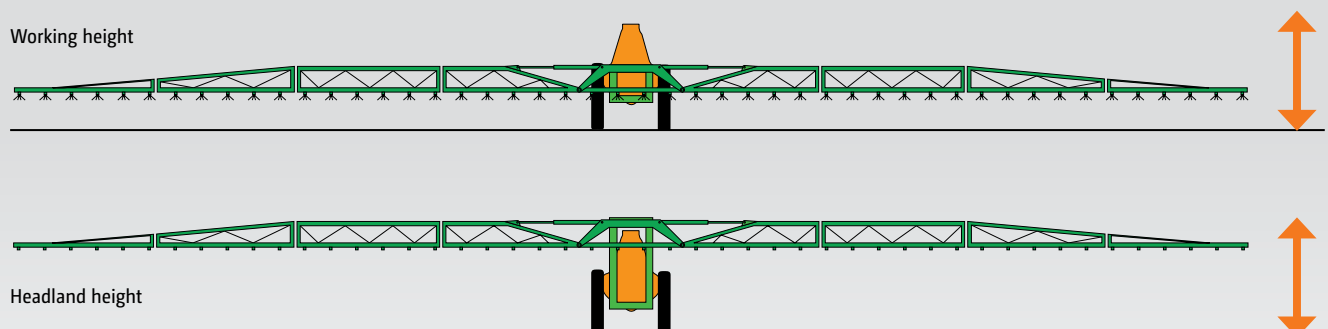

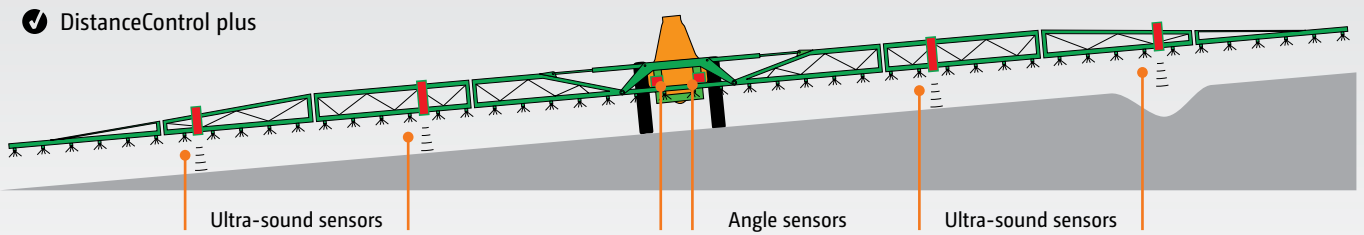

## DistanceControl with 2 sensors or DistanceControl plus with 4 sensors

AMAZONE offers for Super-L booms, either DistanceControl fully automated boom control with 2 sensors or DistanceControl plus with 4 sensors on the Pantera self-propelled sprayer. In heavily differing crop heights, or in areas with partially lodged corn, it could be that the boom, when equipped with 2 sensors, dips into the crop. In this case equipping the boom with four sensors will prevent this. The sensors are electrically connected in parallel and so it is always the sensor that is closest to the target surface that is actuated.

The driver is able to concentrate on correctly applying plant protection agents and the computer optimises the boom height control!

### Benefits of the DistanceControl boom guidance

- ✔ Fully automatic boom guidance including height guidance, tilt adjustment and boom lifting on the headland
- ✔ Automated bilateral boom angling (in combination with Flex-fold 2)



Sensors precisely detect the target height distance and take over the operation.

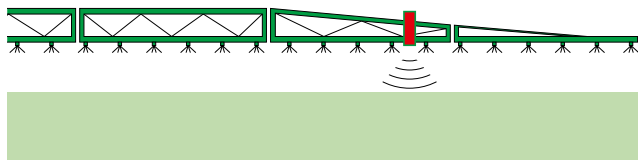

DistanceControl when equipped with two sensors: measuring to the crop

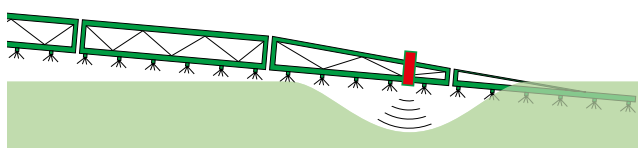

DistanceControl when equipped with two sensors: The boom can dip into the crop, for example, where there is lodged corn

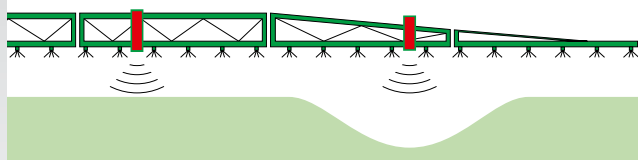

DistanceControl plus: offers the remedy in those more difficult conditions with its four sensors



ContourControl with negative boom angling

## ContourControl – reduces those vertical boom movements

The AMAZONE ContourControl active boom control is a trendsetting and fully automated boom control system for booms widths from 21 m. This fulfils the demand for higher precision during application due the lower target surface distances even at high forward speeds. ContourControl can be used with Super-L booms in conjunction with either Flex-fold 1 or Flex-fold 2.

The basis of the new boom guidance is the highly-responsive, electro-hydraulic system with either 4 sensors or in, combination with the Flex-fold 2, 2 additional sensors which allow control of any negative geometry.

The benefits of the active ContourControl boom guidance:

- ✔ Best possible fully automatic vertical boom guidance – even in those difficult conditions
- ✔ Automatic independent boom angling (in combination with Flex-fold 2)
- ✔ Very quick folding procedures
- ✔ Higher accuracy at faster working speeds
- ✔ Elegant boom control for those wider working widths

Vertical boom movement

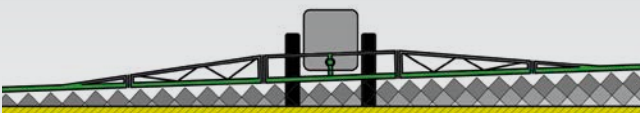

AMAZONE booms ensure that smooth, vertical boom ride

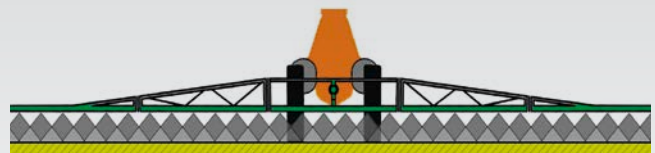





SwingStop: precision that inspires!

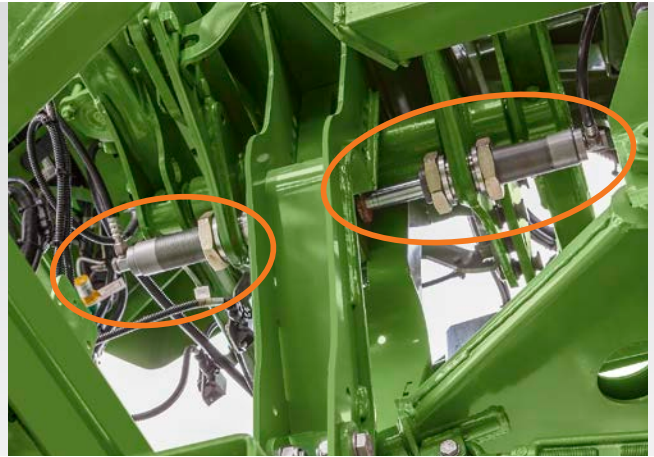

SwingStop features two actively-operated hydraulic rams in the boom centre

## SwingStop – for reducing the horizontal boom movement

For matching the horizontal boom ride to the increasing demands, such as, for example, wider working widths and higher forward speeds, AMAZONE offers, as an option for the ContourControl boom guidance system, the active SwingStop boom tip movement prevention. By external influences, such as ground undulations, driving round bends, acceleration and deceleration and increasing operating speeds the boom is extraordinarily strained in horizontal direction. This may result in the boom ends swinging round and thus negatively affecting the lateral distribution at the outer ends of the booms.

As horizontal movement occurs more at the boom ends, this effect is increased enormously by wider boom widths. To reduce this horizontal swing effect, SwingStop measures, via acceleration sensors, the resulting acceleration at the boom ends. The two actively-operating hydraulic rams in the boom suspension compensate live for these swing movements and in this way provide a very smooth horizontal boom ride.

The benefits of SwingStop:

- ✔ Reduction of the horizontal boom movement
- ✔ A system that operates very quickly, elegantly and precisely
- ✔ Highest performance and outstanding precision

Horizontal boom movements

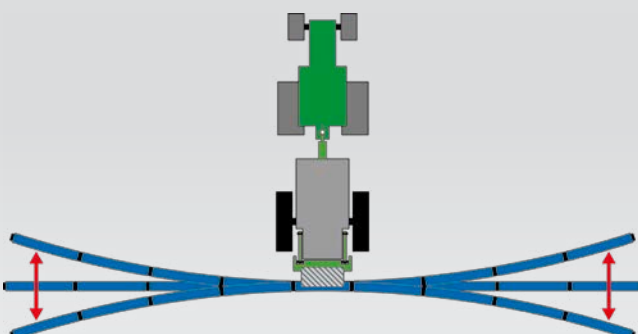



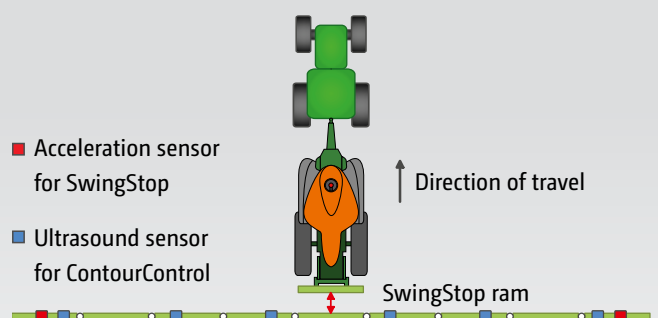

AMAZONE booms with SwingStop for excellent horizontal boom guidance

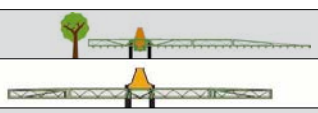

# Overview: boom guidance

For any demand the right solution



Model	
Folding	
Automatic boom guidance (option)	
Number of relevant sensors	
Number of spool valves	
Sprayer boom folding in and out	
One-sided boom folding	
Folding down to a reduced working width	
Bumper buffer device at reduced working width	
Time for the folding procedure	
Height adjustment	
Boom lift on the headland	
Tilt adjustment	
One sided / both sided boom angling	
One sided / both sided boom tip angling	
Active shock absorption against asymmetrical and symmetrical vibrations	
Boom guidance (overall view)	
Recommendation for working widths	
Recommendation for operating speeds	
Recommendation for ground conditions	
Recommendation for working width change	



UX Special							
		UX Super		UX Super			
		UX 11200					
Standard	Pre-select folding	Profi-fold 1	Profi-fold 2	Flex-fold 1	Flex-fold 2	Flex-fold 1	Flex-fold 2
		DistanceControl (plus) 2 (4)				ContourControl 4   6	
2 double-acting / 3 double-acting		1 single-acting + free flow return / Load-Sensing system (Option)					
remote control (spool valve)		remote control (terminal)					
	remote	remote control (terminal)					
remote control				automatic			
option				standard			
normal				quick		very quick	
remote control (spool valve)		remotely controlled (terminal) / automatic with DistanceControl or ContourControl					
remote control		remotely controlled (terminal) / automatic with DistanceControl or ContourControl					
remote control (spool valve)		remotely controlled (terminal) / automatic with DistanceControl or ContourControl					
			automatic		automatic		automatic
						automatic	
						Option (SwingStop)	Option (SwingStop)
good						excellent	excellent
						> 30 m	
medium						extremely high	extremely high
level					hilly	level	hilly
little				often			

# TG part-width section valves



## Electrically-controlled TG valve chest

For either ISOBUS control or AmaSpray<sup>+</sup>, the TG part-width valve chest is available. The part-width boom sections are switched, on and off, quickly and drip-free via electric motor valves with pressure relief.

In all situations the spray rate is exactly and quickly controlled directly via the computer and so negating the need for any mechanical equal pressure control.



# Pressure recirculation system

Efficient and reliable – for all UX trailed sprayers



DUS pressure recirculation system

## The DUS pressure recirculation system – proven more than 10,000 times

The AMAZONE DUS pressure recirculation system ensures a reliable circulation throughout the entire system. When starting the spraying operation all the hoses including the spray lines are filled under pressure in the reverse direction with the mixed spray agent. This means the spray lines are always full and immediately ready to use over the entire working width. There is no waiting on the headland.

Every time individual part-width sections are shut off, during the turning operation and during transport, the spray liquid circulates continually thanks to the pressure recirculation system. This reliably prevents deposits, blockages or segregation in the spray lines.

During the cleaning operation, fresh water flushes the spray lines out right up to the nozzles without any spraying being necessary. During this cleaning procedure, the concentrated spray liquid is returned back to tank via the pressure recirculation system leaving the spray lines clean.

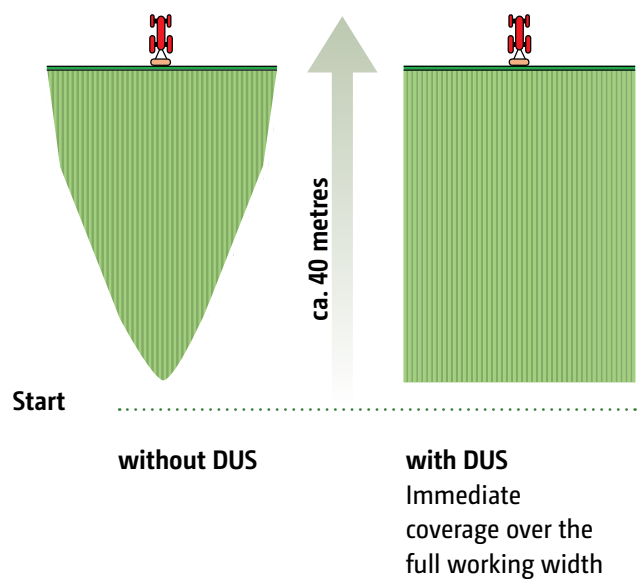

## DUS pressure recirculation system: supplies each individual part-width section

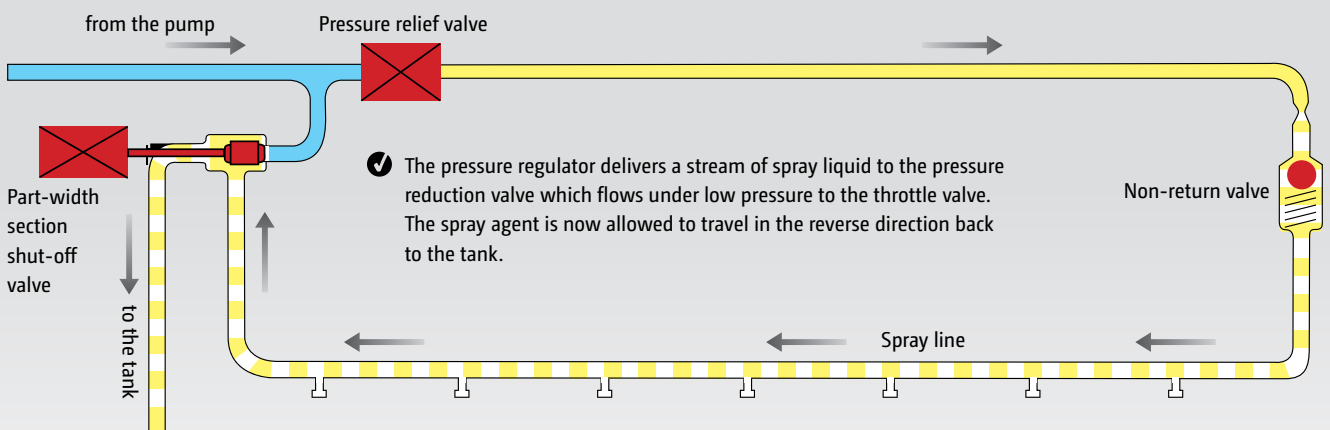

# AmaSwitch

**Electric individual nozzle switching with 50 cm part-width sections**

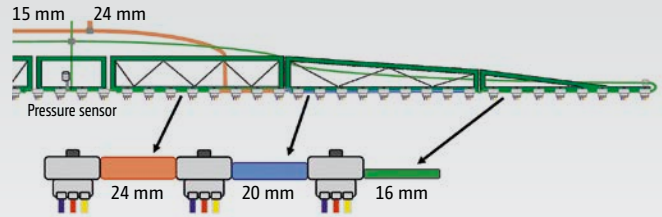

DUS pro high pressure recirculation with conical spray line on here, for example, AmaSwitch

## Automatic 50 cm part-width section switching

With AmaSwitch, AMAZONE offers the precise solution for automatic part-width section control on 50 cm sections. AmaSwitch is the ideal alternative for users who want to maximise the benefits of very precise switching in wedge shaped fields and areas of overlap, thanks to the 50 cm part-width section control.

Standard equipment with AmaSwitch includes the DUS pro high pressure recirculation system and, in addition, can be equipped with LED individual nozzle lighting.

## 3-fold nozzle body, with electric on/off switching

The technology behind AmaSwitch is based on a conventional, manually-rotated, 3-fold nozzle body with electric individual on/off. The opening and closing is achieved via an electric valve which is fixed directly onto the nozzle body. In conjunction with GPS-Switch, it is thus possible to very precisely control 50 cm part-width sections in short work and on the headland. In addition to the automatic switching using 50 cm part-width sections, it is possible to configure the amount of part-width sections from choice.

## DUS pro

With DUS pro, the spraying pressure is constant right up to each individual nozzle and at the set spraying pressure. Thanks to the conical spray lines, minimal residual spray volumes are achieved.

### Conical spray line:

The dimensions of the spray line vary along the boom

- ✔ Minimum residual volumes
- ✔ Even flow speed
- ✔ Standard equipment with AmaSwitch and AmaSelect

## 4-fold nozzle body, with the additional 25 cm nozzle spacing

In addition to the 3-fold nozzle body, AmaSwitch electric single nozzle control can also be equipped with a 4-fold nozzle body. In addition, a true 25 cm nozzle spacing can be achieved with the aid of an optional extension kit. This offers the benefit, in combination with specific 80° nozzles, to reduce the boom to target surface distance down to less than 50 cm.

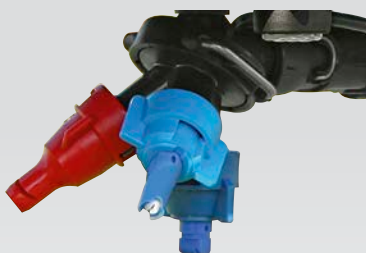

AmaSwitch 3-fold nozzle body with individual nozzle lighting



AmaSwitch 4-fold nozzle body

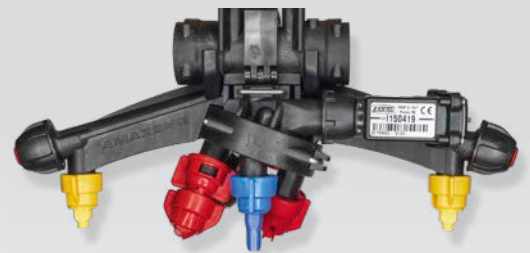

AmaSwitch with 4-fold nozzle body and extension set for an actual 25 cm nozzle spacing

# AmaSelect

## Electric individual nozzle switching with 50 cm part-width sections

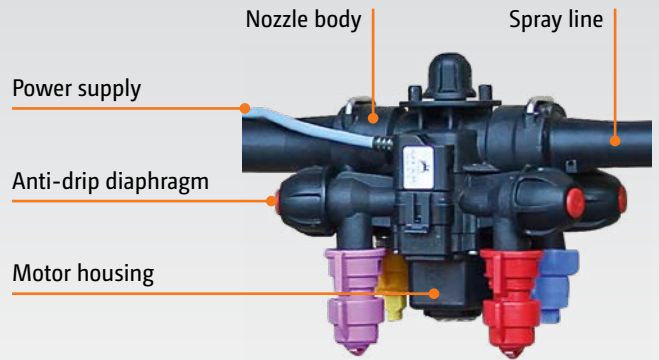

🔌 AmaSelect – components of the system

### Modern application technology

The electric AmaSelect individual nozzle control consists of a 4-fold nozzle body with electric on/off control plus the additional switching over of either a nozzle or a combination of nozzles. So, the system, in addition to the 50 cm boom part sections which can be switched automatically via GPS-Switch, offers a changeover electrically between the four fitted nozzles via the operator terminal or, when required, completely automatically. Via the input of the optimum pressure range of each individual nozzle within the 4-fold nozzle body, the system automatically switches the nozzles according to these specifications. This offers the possibility, for instance when leaving the optimum pressure range of a nozzle, to switch on a second nozzle or to changeover to a larger nozzle. It is possible, how-ever, to freely configure any number of part-width sections with also any number of nozzles. Just for farmers or agricultural contractors with different tramline systems, a simple matching of the nozzle switching with the relevant working width is possible. As standard, AmaSelect is equipped with DUS pro high pressure recirculation and LED individual nozzle lighting.

### HeightSelect for the UX Super

With the aid of HeightSelect (only in conjunction with AmaSelect and ContourControl) now also the distance between boom and the targeted crop is continuously matched automatically in relation to the nozzle spacing and nozzle type. When the nozzle has been switched on, the automatic boom guidance system controls the appropriate target distance. This automation improves the efficiency of the crop protection agent used as well as decisively relieving the stress on the driver.

### With 50 cm or 25 cm nozzle spacing

As an option, the AmaSelect nozzle body can also be equipped with an off-set kit giving 25 cm nozzle spacing. This, in conjunction with special 80° nozzles, offers the benefit of reducing the target height above crop to below 50 cm. In addition, this version can be supplemented by the HighFlow option for applications with extremely high application rates.

### Principle of function: HeightSelect

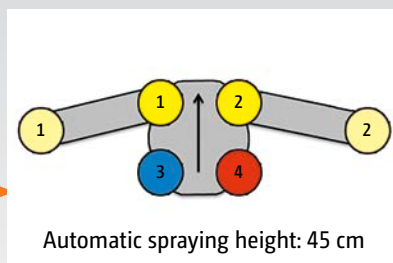
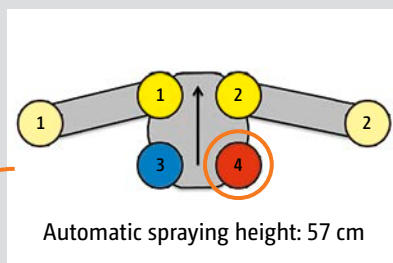

# Electric individual nozzle control

Example: 24 m boom width

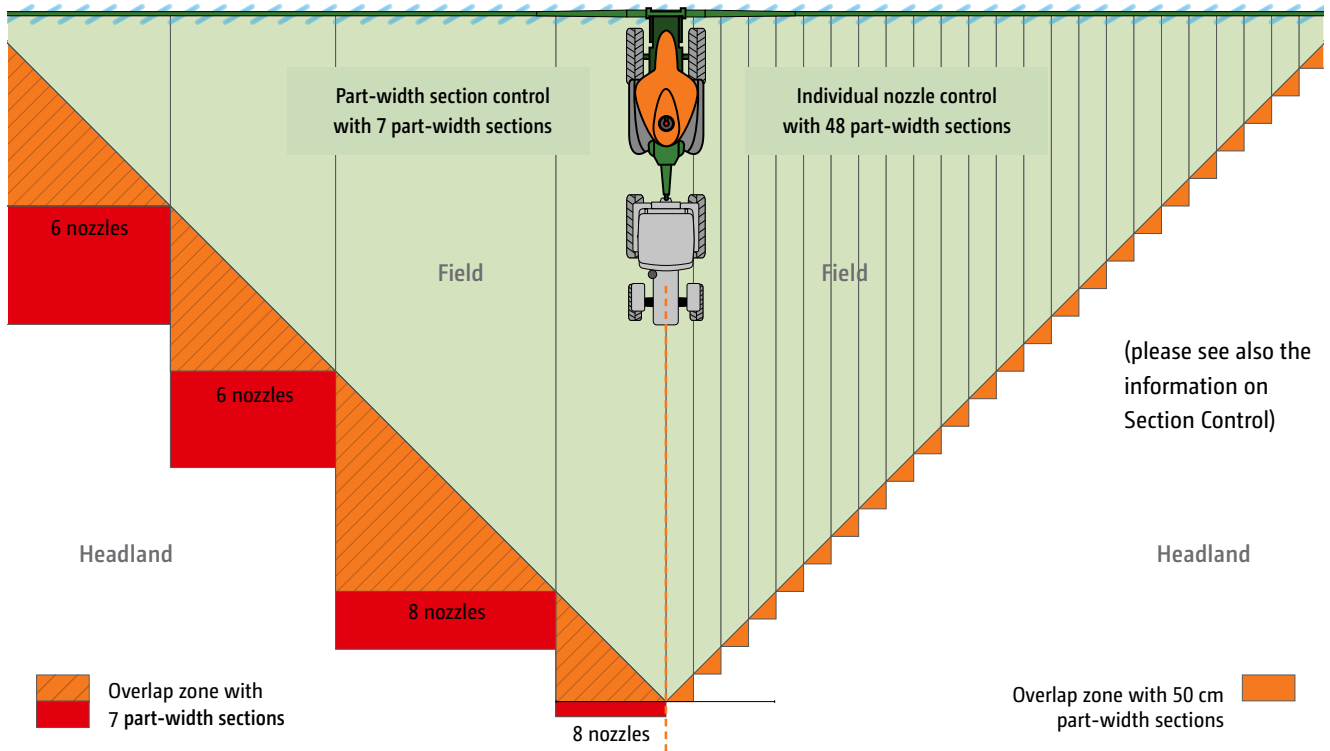

✔ AmaSwitch electric individual nozzle switching



✔ AmaSelect electric individual nozzle control





### Calculated example:

Annual average overlaps of **conventional part-width sections vs 50 cm part-width sections in combination with Section Control**

### Important field analysis knowledge

- ✔ Average overlap with 50 cm part-width sections only 1.92%
- ✔ Average overlap with 9 part-width sections 7%
- ✔ Short payback period for large farms due to annual saving potential
- ✔ Due to smaller field sizes, smaller farms save proportionally more
- ✔ When growing crops with a high crop protection demand (e.g. potatoes, beet), the 50 cm part-width section is particularly cost-effective

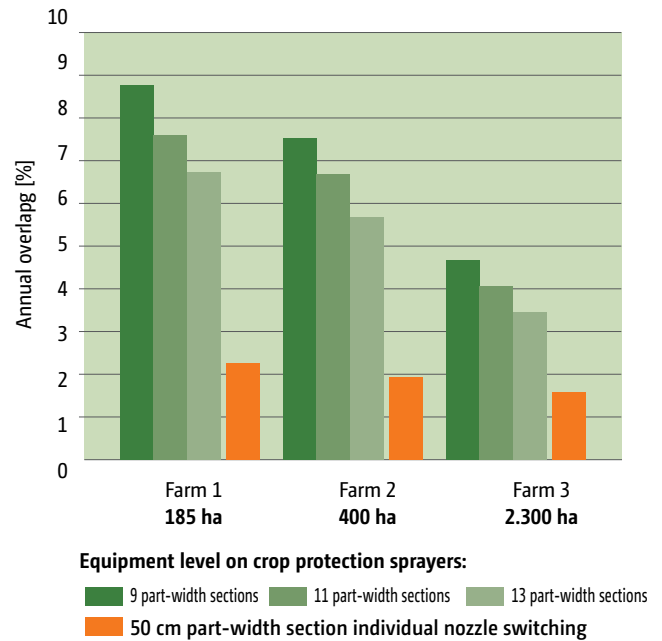

### The systems in comparison:

Your benefits	Standard valve chest	AmaSwitch 3-fold	AmaSwitch 4-fold	AmaSelect
Multiple boom sections	up to 13	up to 80	up to 80	up to 80
50 cm part-width sections	-			
Number of nozzles per nozzle body	1, 3, 4	3	4	4
Manual nozzle switching				-
Automatic nozzle changeover and switching	-	-	-	
Nozzle selection from the cab	-	-	-	
Nozzles used in combination	-	-	-	
High pressure recirculation (DUS pro)	-			
25 cm nozzle spacing		-		
Individual programming of the part-width sections (TB)	-			
No need for compressed air				
LED individual nozzle lighting				

# Electric boundary nozzle switching

For environmentally-friendly spray application at the field edge



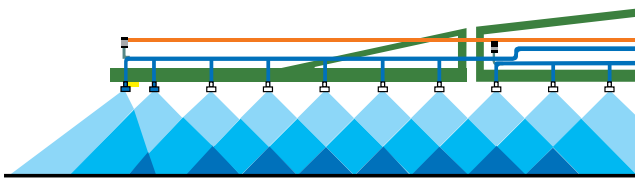

#### Additional nozzle switching

In order to extend the normal working width, an asymmetrical nozzle can also be switched on. This is particularly useful if the distances between tramlines are not precise enough.

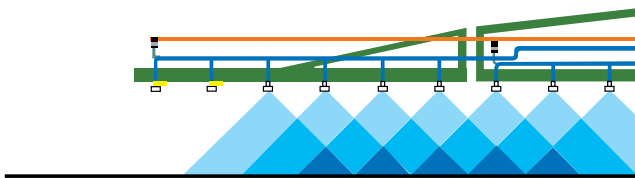

#### End nozzle switching

If a one metre buffer zone around the edge of the field needs to remain unsprayed due to distance constraints, end nozzle switching can be used.

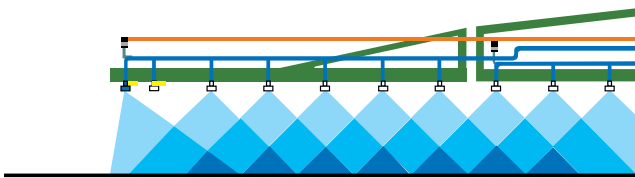

#### Boundary nozzle switching

For precision border spraying between two sensitive crops, the boundary nozzles can be used to make sure the spray pattern is accurately defined.

# The right nozzle choice

The basis for success in crop protection



## Less drift also at higher wind speeds

With the air-assisted injector nozzles, crop protection agents can be applied with very little drift. They are universally usable in all crops and all classifications. Because of the coarse droplet application, these nozzles can also be used in higher wind speeds.

AMAZONE offers a wide range of nozzles from agrotop, Lechler and TeeJet.

## Single and multi-nozzle bodies

The nozzle bodies with integrated diaphragm non-return anti-drip valves fit up into the boom profiles reliably preventing any dripping at the nozzle. Self-adjusting bayonet fixings ensure a tool-less quick nozzle change. The 3-fold or 4-fold nozzle bodies are suited to frequent nozzle changes due to different applications and crops. Nozzle protection tubes, as standard on the outer sections, or, if desired, over the entire boom working width, ensures protection for long injector nozzles and multiple nozzle bodies.





Examples

- 1) Lechler IDN 120-025
- 2) Teejet XRC 110-025
- 3) Air-injection nozzle AirMix 110-04



Everyone purchasing an AMAZONE crop protection sprayer receives, free of charge, an nozzle mounting tool that enables a much easier nozzle change.

Injector nozzles (ID, TTI) have a relatively coarse droplet spectrum and are particularly versatile with regard to their field of application. A pressure range of 2 to 8 bar is possible.

The split spray pattern ensures a more even deposit on the front and back of the plant and makes sense maybe, for example, in ear treatment.

If coverage quality is at the foreground of the application, the use of standard or anti-drift fine droplet nozzles, such as XR or AD, is recommended. Special care is required here due to the tendency to drift above 3 bar.

For speeds greater than 10 km/h, the TD HiSpeed nozzle with its asymmetrical spraying angle is becoming a new industry trend.

A good compromise is provided by the modern ID-K or Airmix compact injector nozzles. These have relatively little drift, but do not have too coarse a droplet spectrum and are operated at 2 to 4 bar.

When it comes to special coverage qualities the double flat fan nozzle is an interesting alternative: the AVI Twin from agrotop also produces droplets that are not too fine.

Distribution of the droplet size

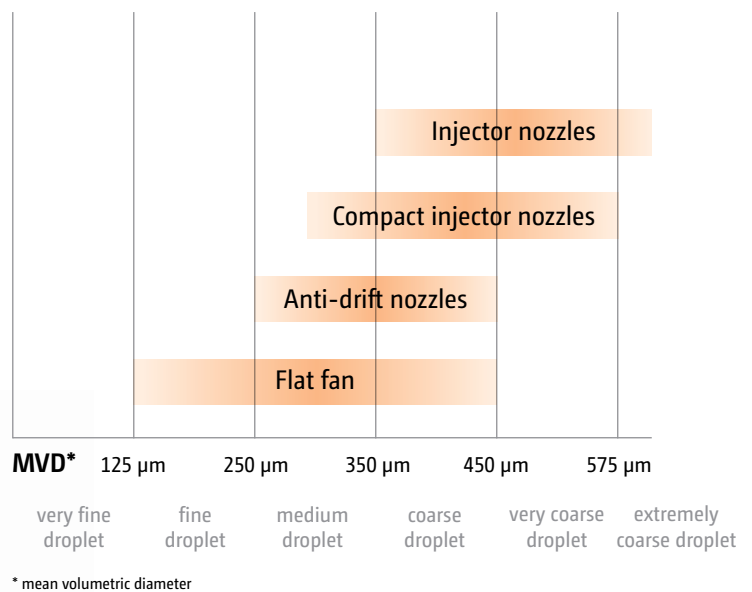

# Equipment that meets any demand



## Liquid fertilisation

The UX trailed sprayers are particularly suited to liquid fertilising: the use of high grade plastic material, a good paint-work and the virtually exclusive use of stainless steel ensures a long life even with liquid fertiliser operation. In conjunction with the Super-S2 boom a separate drag hose unit is available.

## Multi-hole nozzles

For the distribution of liquid fertiliser in coarse droplet size, either multi-hole nozzles (3 or 7 hole) or the FD sluice nozzles are available on request.



## Under-leaf spraying

Also elegant solutions for successful under-leaf spraying are possible in combination with AMAZONE plant protection sprayers. The Dropleg system from Lechler is a freeswinging, under-leaf spraying device that works across the rows and is an example of an easy and robust solution that fulfils the most professional of demands.



✔ Stainless steel weights on the drag hose

✔ Dropleg system



## LED individual nozzle lighting

Professional work lighting is today the basis of a flexible, output-increasing solution to operating in twilight and at night. LED individual nozzle lighting picks out each individual spray fan. An absolutely immediate assessment of their operation down to the very last nozzle on the boom can be made.

## LED work lights

Boom lighting is provided by two LED work lights mounted in the centre of the boom and, from here, due to their wide-reaching illumination; prove to be a particularly effective execution.

Two further LED work lights to give additional background lighting can be mounted up on the platform.

## Camera system to the rear of the UX trailed sprayer

The optionally available camera system mainly serves for safety when manoeuvring. It is also a super aid when monitoring the function of the nozzles directly behind the machine. This is ensured even in rain, twilight or in darkness via infrared LEDs and a heated lens. The high resolution, antiglare monitor is backlit and can also display two cameras at once.



- ✔ With the analog video input on AmaTron 4, the picture from the camera can also be displayed alternatively.

- ✔ With the spray lance of the exterior wash down kit, the outside of the crop protection sprayer can be thoroughly cleaned after use whilst still in the field.



# ISOBUS –

Machine actuation in the digital age

MEMBER OF



## One language, many benefits!

Each ISOBUS-enabled machine from AMAZONE comes with the latest technology and almost unlimited possibilities. It does not matter whether you use an operator terminal by AMAZONE or an ISOBUS terminal directly installed in your tractor. ISOBUS is a worldwide recognised communication standard between, on the one hand, operator terminal, tractor and connected implements and, on the other hand, agricultural office software.

## Operation with any ISOBUS terminal

Which means that ISOBUS enables you to take control of all your ISOBUS compatible equipment. You just connect the machine with the relevant ISOBUS terminal and immediately the normal operator interface is displayed on the monitor screen in your tractor cab.

### Benefits of ISOBUS:

- ✔ This worldwide standard provides a uniform interface and data exchange formats that ensure the compatibility even with third party manufacturers
- ✔ Plug and Play between machine, tractor and additional ISOBUS implements





# AMAZONE – more than just ISOBUS

Improved control, more yield! Precision Farming 4.0

## Our competence in electronics

To increase the operational comfort, AMAZONE implements and operator terminals feature a scope of functionality way beyond ISOBUS standards.

### The benefits of more than just ISOBUS:

- ✔ Highest compatibility and safety functionality of your ISOBUS equipment
- ✔ No additional modules on the machine side. All ISOBUS machinery from AMAZONE is already equipped as standard with the necessary ISOBUS functions
- ✔ MiniView display with all AMAZONE terminals and additional ISOBUS terminals. See, for instance, the machine data in the GPS view
- ✔ The possibility using the tractor terminal or in a twin terminal solution to separate the functionalities of tractor and connected implement
- ✔ Unique operation concept. Freely-configurable displays and individual user interfaces in the operator terminal
- ✔ Up to 3 user profiles are possible. Establish for every driver or operation an individual user profile!
- ✔ Freely-configurable machine operation as, for instance, the folding procedure of the booms of your AMAZONE crop protection sprayer
- ✔ Tractor ECU function evaluation  
Automated movement sequences such as automated blocking of the steering axle while reversing
- ✔ Integrated TaskController data logger. As a matter of principle, every ISOBUS telemetry solution is possible (for example, TONI telemetry from CLAAS).
- ✔ Freely-configurable part-width sections



# Make the most of the possibilities

## Job management and documentation

All standard ISOBUS terminals from AMAZONE can collect and save machine and site-specific data using Task Controller. The collected data can subsequently be used in your Farm Management Information System.

- ✔ Easily compile or load jobs
- ✔ Processing jobs
- ✔ Document and export the work performed
- ✔ Processing of application maps in an ISO-XML format

## GPS-Track

The GPS-Track parallel tracking aid makes orientation in the field much easier, particularly on grassland or in areas without tramline tracks. It has various track modes such as A-B Line and contour lines. Deviation from the ideal track is graphically shown on the display by an integrated light bar. Thanks to the clear steering recommendations with exact tramline distances you always remain on track!

- ✔ The virtual light bar in the status bar
- ✔ is standard for AmaPad 2
- ✔ and optional for the AmaTron 4

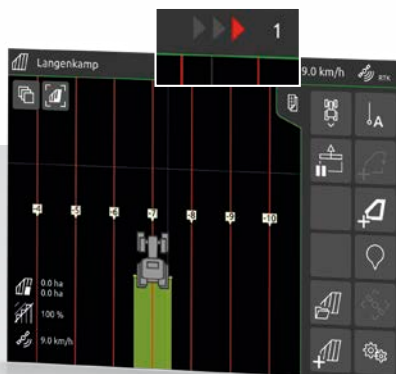

GPS-Track – your parallel driving aid in the field

## GPS-Maps

GPS-Maps enables uncomplicated part-area site specific management because this software module provides easy use of application maps in a shape file format. Either the target amount of the material to be applied or the target amount of effective ingredient can be directly processed.

- ✔ Intuitive system for working from application maps
- ✔ Automatic part-area site specific regulation of the application rate
- ✔ Optimum crop management via need-oriented application
- ✔ Standard on AmaTron 4 and AmaPad 2



GPS-Maps – part-area, site specific application



# agrirouter –

The independent data hub for agriculture



## Simple and safe data exchange

agrirouter can work with products and services from different manufacturers and facilitates universal data exchange for AMAZONE. agrirouter provides a safe and easy way to exchange data between AMAZONE machines, agricultural software, manufacturers and companies.

## Full control – choose for yourself!

agrirouter simplifies data exchange by allowing wireless exchange of job data and application maps between AMAZONE machinery. It simplifies operating procedures, reduces administrative effort and improves profitability. You retain control of the data and decide who gets which data and to what extent.

### Advantages of agrirouter:

- ✔ Simple and easy handling
- ✔ Comfortable and fast transfer
- ✔ Full control of your data
- ✔ Data are transferred, not stored
- ✔ Manufacturer-independent use

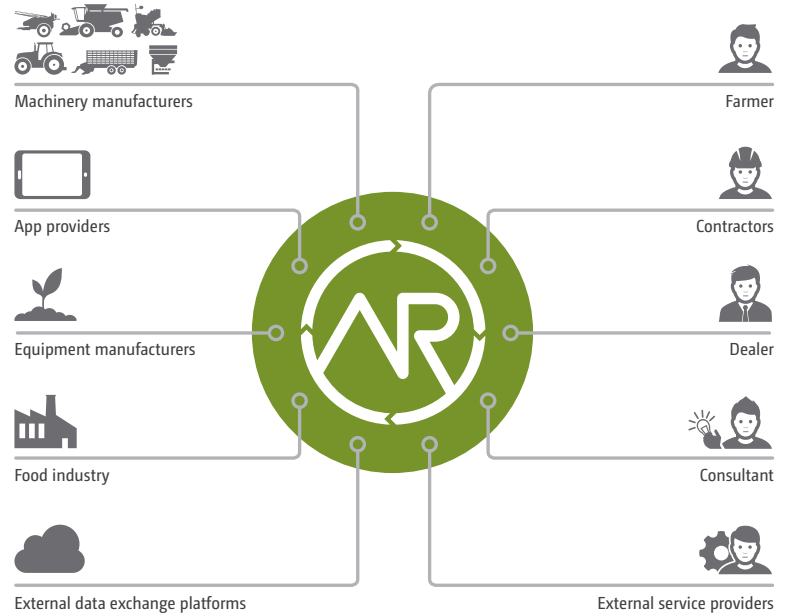

Source: DKE-Data GmbH & Co. KG



AMAZONE implements the connection to ISOBUS machines by using the AmaTron 4

# Automatic GPS-Switch part-width section control with Section Control

Example: 24 m boom width (6-6-8-8-8-6-6 = 48 nozzles)

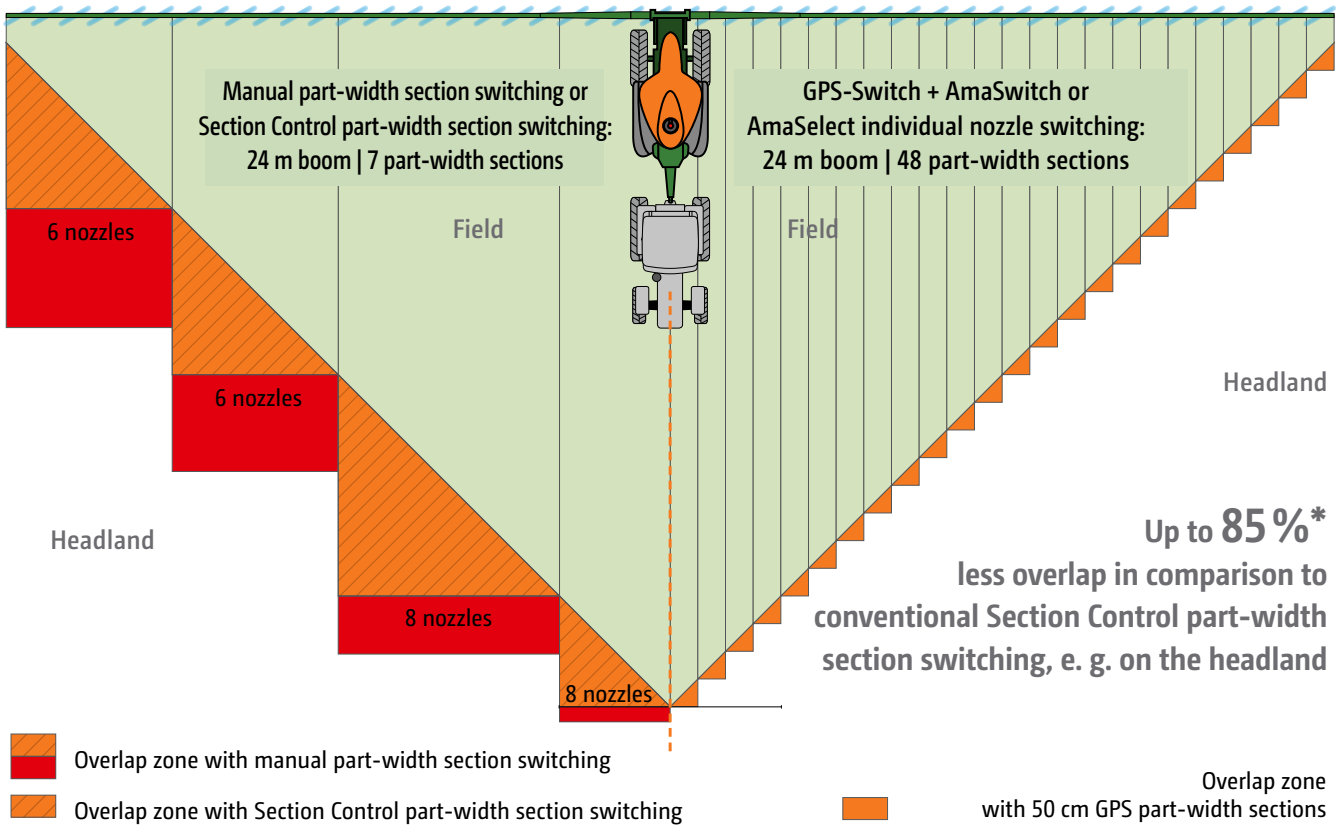

Automatic part-width shut-off for the headland and wedge-shaped fields **GPS-Switch**

**5%\***

Saving of crop protection agent



Electric individual nozzle switching **AmaSwitch or AmaSelect**

**5%\***

Additional saving of crop protection agent

\* Savings are dependent on field structure, boom width and the number of part-width sections

## Precise switching in 50 cm part-width sections

The decisive benefit of the individual nozzle control is the possibility to operate with small part-width sections giving an even greater degree of precision in wedge shaped fields, short work and on the headland. If AmaSwitch or AmaSelect is combined with the automatic GPS-Switch Section Control, the automatic switching of individual nozzles in 50 cm part-width sections is made possible. With this system, areas of overlap

are significantly reduced and are, in comparison with a conventional Section Control part-width section shut-off system, up to 85 % less. So, the combination of GPS-Switch and individual nozzle control results, depending on field shape and size, working width and number of part-width sections, in significant savings of spray agent compared with a normal spraying system used thus far.

## Automatic part-width section control

If the terminal to be operated features Section Control, such as, for example, GPS-Switch part-width section control from AMAZONE, the switching of the part-width sections can be carried out completely automatically and in relation to the GPS position. Once a field has been established by the driver, then, in the automatic mode, they can fully concentrate on handling the vehicle whilst the switching of the part-width sections in wedges and on the headland is carried out automatically.

### Benefits of automatic part-width section control:

- ✔ Stress relief on the driver
- ✔ Increase in precision especially at night or at higher speeds
- ✔ Less overlaps and gaps
- ✔ Saving of resources
- ✔ Less crop damage and environmental pollution

❗ “With Section Control, the ISOBUS computer relieves the driver from a lot of work.”

(“dlz agrar magazine” – “Test report ZA-TS fertiliser spreader”. 02/2017)

## GPS-Switch

With GPS-Switch, AMAZONE offers a GPS-based, fully automatic, part-width section control for all AMAZONE operator terminals and ISOBUS compatible fertiliser spreaders, crop protection sprayers or seed drills.

### GPS-Switch basic

- ✔ Automatic part-width section control of up to 16 part-width sections
- ✔ Optional for AmaTron 4

### GPS-Switch pro

- ✔ Automatic part-width section control of up to 128 part-width sections
- ✔ Creation of a virtual headland
- ✔ Creation of Point of Interests (POI)
- ✔ Automated boom lowering for an AMAZONE sprayer
- ✔ Standard for AmaPad 2
- ✔ Optional for AmaTron 4

### ✔ AmaClick

Special crops and bed work often require the on/off switching of the individual part-width sections in the middle of the boom. AmaClick is an additional ergonomic control unit that can be used either in conjunction with the multi-function joystick or also though as a standalone system alongside an ISOBUS terminal.



# ISOBUS terminals from Amazone

Intuitive, comfortable, better – workday made easy

## From simple to high-tech – everything is possible

AMAZONE offers two particularly convenient operator terminals for your ISOBUS machinery in the form of the ISOBUS-compliant AmaTron 4 and the AmaPad 2. In addition to pure machine operation, there are additional application options, such as automated GPS-Switch part-width section control.

- ✔ All applications come pre-installed and can be initially tested free of charge
- ✔ Intuitive and clear actuation

## Everything in view with the 2-terminal solution

As well as operating the AMAZONE ISOBUS machine through the tractor terminal, there is also the handy alternative of separating the functionalities of the tractor and the attached machine and operating them by using two terminals. The tractor terminal can continue to control the tractor or also display the GPS applications whereas the additional operator terminal in its UT display mode is fully utilised to monitor and control the machine.



Terminal	AmaTron 4	AmaPad 2
Display	8 inch, multi-touch colour display	12.1 inch, multi-touch-colour display
Mode of operation	Touch and 12 soft keys	Touch
Interfaces	1 x Ethernet 2 x RS232 (GPS & ASD) 2x USB interfaces	1 x Ethernet 2 x RS232 (GPS & ASD) 2x USB interfaces with WLAN dongle
Job management and processing of application maps (ISO-XML and Shape)	GPS-Maps&Doc * with integrated Task Controller	Task Controller
Parallel driving aid	GPS-Track * with virtual light bar	GPS-Track pro with virtual light bar
Automatic track following	–	GPS-Track Auto for the Pantera self-propelled crop protection sprayer
Automatic part-width section control (SectionControl) Note: dependent on the max. no. of sections of the machine!	GPS-Switch basic * with up to 16 part-width sections or GPS-Switch pro * with up to 128 part width sections	GPS-Switch pro with up to 128 part width sections
Camera connectivity	1x camera connection * with AmaCam automatic reversing detection	2x camera connections *

\* = optional



## Everything from a single source!

Thanks to the AUX-N feature, you can operate multiple functions of the machine via AmaPilot+ or any other ISOBUS multi-function joystick.



### The benefits of AmaPilot+:

- ✔ Perfect ergonomics
- ✔ Almost every function directly controlled via 3 levels
- ✔ Adjustable palm-rest
- ✔ Freely-programmable, individual key layout
- ❗ "The joystick rests comfortably in the hand."  
("dlz agrar magazine" – "Test report Pantera 450Z" · 02/2016)



- ❗ "The ISOBUS control is an in-house development from AMAZONE and has been designed clearly and is easily understandable. If desired, some keys can be freely allocated. Also the multi-function display can be freely selected."  
("agrarteute" magazine – "Test report Centaya seed drill" · 06/2018)

# AmaTron 4

## Manager 4 all



### Easy and comfortable operation as intuitive as your tablet

Why not handle a terminal as intuitively like a tablet or a smartphone? With this in mind AMAZONE has developed the highly intuitive and operator-friendly AmaTron 4 which offers a noticeably smoother operational process, especially when it comes to job management. The AmaTron 4, with its 8" multi-touch colour display meets the highest expectations and offers maximum user-friendliness. A swipe of the finger or using the App carousel allows quick changes between applications and the simple and clearly structured operating menu. A useful MiniView, a freely configurable status line as well as a virtual light bar make the use of the AmaTron 4 particularly clear and convenient.

#### Benefits of AmaTron 4:

- ✔ Automated full image mode during non-operation
- ✔ Practical MiniView concept
- ✔ Operation via the touch display or via soft keys
- ✔ Especially intuitive and user-friendly
- ✔ Field-related documentation
- ✔ Practice-oriented and intelligent menu guidance
- ✔ Day-night mode

Standard with:

***GPS-Maps&Doc***



- ✔ Automated AmaCam reverse driving recognition that gives direct access to a reversing camera and prevents dangerous situations

- ✔ Machine operation (UT, Universal Terminal) in day-night mode



# AmaPad 2

The especially comfortable way to control agricultural machinery



## The new dimension of control and monitoring

AmaPad 2 from AMAZONE is a particularly high-quality operator terminal. The 12.1" multi-touch colour display is particularly comfortable and fulfils the highest demands on Precision Farming. The operation of AmaPad is carried out solely via touch.

With the practical "MiniView concept", applications which aren't being actively operated at that moment but need to be monitored are clearly displayed at the side. When needed these can be enlarged via "a finger swipe". The possibility to individualise a "dashboard panel" with the displays of choice rounds up the user ergonomics.

In addition to the GPS-Switch pro part-width section control, GPS-Track pro, a high-end parallel tracking aid with virtual light bar is included in the standard specification.

### Benefits of AmaPad 2:

- ✔ Large 12.1" multi-touch colour display
- ✔ Extended MiniView concept
- ✔ Upgrade to automatic steering is possible thanks to the automatic GPS-Track Auto track guidance
- ✔ Day-night mode

Standard with:

***GPS-Maps pro***  
***GPS-Track pro***  
***GPS-Switch pro***



# Technical data: UX trailed sprayers



Machine model	UX 3200 Special	UX 4200 Special	UX 5200 Special	UX 4201 Super	UX 5201 Super	UX 6201 Super	UX 11200
Nominal volume (l)	3,200	4,200	5,200	4,200	5,200	6,200	11,200
Tank capacity (l)	3,600	4,600	5,600	4,600	5,600	6,560	12,000
Fresh water tank (l)	320	550	550	580			900
Working width (m)	15 – 36			21 – 40			24 – 40
Transport height (m)	Super-S2 boom: 3.25 – 3.40 Super-L2 boom: 3.35 – 3.50			3.35 – 3.50			3.90
Transport length (m) with Super-S2 boom	6.25 – 6.50	6.85 – 7.30		–			–
Transport length (m) with Super-L2 boom	6.40 – 6.65	7.25 – 7.50		6.85 – 7.50			9.70
Transport width (m) Super-S2 boom:	2.40			–		–	–
Transport width (m) Super-L2 boom:	3-section 2.40 4-section 2.65			3-section: 2.40 4-section: 2.65		3-section: 2.60 4-section: 2.80	2.85
Transport width (m) Super-L3 boom:	–			3-section: 2.55		3-section: 2.75	–
Empty weight (kg)	2,908 – 3,344	2,998 – 3,434	3,096 – 3,652	3,500 – 4,998	3,707 – 5,042	3,959 – 5,221	7,870 – 8,284
Pump capacity (l/min)	260/380		380	520			750
Max. suction capacity (l/min)	400/500		500	700			900
Ground clearanc	up to 0.82 m (with tyres Ø 1,835 mm)						
Spraying height	0.5 – 2.5 m (with tyres Ø 1,835 mm)						
Operational pressure, max. (bar)	< 10						

Illustrations, content and technical data are not binding! Deviations of technical data are possible depending on the equipment. The illustrations may deviate from the requirements for local road traffic regulations.



### The small alternative – The UG trailed sprayer

For smaller farms, AMAZONE offers the UG trailed sprayer with tank capacities of 2,200 or 3,000 litres. For detailed information, please see the separate UG leaflet.



**AMAZONE**



**AMAZONEN-WERKE H. Dreyer GmbH & Co. KG**

P. O. Box 51 · D-49202 Hasbergen-Gaste/Germany

Phone: +49 (0)5405 501-0 · Fax: +49 (0)5405 501-193