



Tractors

XERION

5000 4500 4200





Working hard to make your job easier.

XERION 5000-4200

Test drive the new XERION.

Some tractors are comfortable being pushed to their limits. Doing what they are built to do. Like the XERION. Uniquely designed for maximum traction, pulling performance and dynamism.

And since we listen to our customers, we know that even the best machines always have a little room for improvement: a chassis that is more gentle on the soil, even more impressive engine power and even more user-friendly controls. Test drive the new XERION. Making hard work easier.



Discover the new XERION in all its versatility.

Scan me.







XERION 4200.  
462 hp even in the  
entry-level model.  
**Page 16**



Power equals efficiency. High drive  
comfort and ample power for  
attached implements.  
**Page 18**



CEBIS with touchscreen. Built into  
the new tractor armrest.  
**Page 36**



1,000 h maintenance interval. 38%  
reduction in servicing costs, 50%  
less time in the workshop.  
**Page 46**

<b>Innovations</b>	<b>4</b>
<b>The TRAC concept</b>	<b>6</b>
TRAC	8
TRAC VC	10
SADDLE TRAC	12
<b>CLAAS POWER SYSTEMS</b>	<b>14</b>
Engine	16
Transmission	18
Construction	20
Running gear	22
Ballasting	24
Hitches and PTO	26
Hydraulics	28
Front and rear linkage	30
<b>Cab and comfort</b>	<b>32</b>
Comfort	34
Control concept	36
<b>Digitalisation</b>	<b>38</b>
CSM headland management	40
Steering systems	42
Data management	44
Maintenance	46
CLAAS Service & Parts	48
Features	50
Technical data	51



Discover all the new  
features of the  
XERION.  
[xerion.claas.com](http://xerion.claas.com)

Scan me.





Three versions. Unique build concept.

There is nothing quite like the XERION. You'd recognise it instantly: four equal-sized wheels on two steered axles, full-frame construction for carrying enormous loads, continuously variable transmission up to 530 hp and the intuitive operation that you only get from CLAAS.

- TRAC with fixed cab (page 8)
- TRAC VC with rotating cab (page 10)
- SADDLE TRAC with room for a mounted tank (page 12)

**Six benefits. Endless possibilities.**

- Four equal-sized wheels or dual tyres convert engine power into tractive power
- Two steered axles offer five steering modes for a wide range of applications
- Add up to 6.8 t ballast at the front and rear
- The fully load-bearing frame can support loads of up to 15 t per axle

- Continually variable transmission delivering up to 530 hp helps you to reduce fuel consumption
- Operate the XERION intuitively with the CEBIS touchscreen



# XERION TRAC.

## Unbeatable in the field.

TRAC with central cab.

The XERION TRAC is the best option if arable work is your main focus. It has a suspended comfort cab in the middle of the vehicle and large windows for unique all-round visibility.

### The benefits for you.

- In the field you have the advantage of high traction and enormous pulling power
- Ballasting and a swan neck hitch ensure that all loads are evenly distributed cross the two driven axles
- The large tyre contact area protects the soil

### Applications.

#### Tillage.

Four equal-sized wheels provide excellent tractive power. The weights are ideally distributed and the machine is very easy to ballast.

#### Drilling.

You can achieve high work rates and save fuel thanks to the carefully tuned engine management system.

#### Field transport.

Superb pulling power gets the job done quickly. The CMATIC transmission offers a high level of driving comfort.

#### Slurry application.

Power hydraulics deliver 250 l/min. The turning circle is just 15.7 m and crab steering protects the soil.





# XERION TRAC VC.

Reversing has never been so comfortable.

TRAC VC with the rotating cab.

Some applications require particularly good visibility to the rear of the tractor. The rotating cab (VC stands for Variable Cab) is the most convenient reverse-drive system imaginable. At the press of a button, you can rotate the entire cab from its central position to the rear-facing position above the rear axle in seconds.

#### The benefits for you.

- Perfect view of rear attachments
- The controls rotate automatically with the cab
- All functions remain the same when operating in the rear position
- The new armrest with integrated CEBIS touchscreen makes it even more straightforward to operate
- Enjoy a high level of on-road comfort with the cab in the central position

#### Applications.

##### Silo operations.

Enormous pushing power combined with crab steering for optimal compaction.

##### Wood chipping.

The XERION is ready to go, with excellent all-round visibility and plenty of power through the PTO.

##### Mulching.

High power is delivered to the PTO even at low speeds, reducing your hourly fuel consumption.

##### Snow blowing.

CMATIC enables precision driving from a speed of 0.05 km/h. Ground clearance is impressive and you get an unrestricted view.





# XERION SADDLE TRAC.

## It won't let you down.

### Plenty of room for mounted implements.

In the SADDLE TRAC, the cab is in a fixed position above the front axle, leaving ample space behind the cab for a wide variety of implements. A mounted tank, for example, turns the XERION into a self-propelled manure spreader with plenty of power left for slurry application and incorporation.

The XERION SADDLE TRAC is a dependable load carrier you can also rely on to do any other jobs on your farm that call for a large tractor.

### The benefits for you.

- A range of mounted implements turn the SADDLE TRAC into a fully self-propelled vehicle
- Even load distribution allows you to get out onto your fields much earlier in the spring
- Four large tyres combined with crab steering help to protect the soil even during heavy draught work
- With 462 hp and 2,200 Nm torque, the XERION 4200 has ample reserves

### Applications.

#### Manure and digestate spreading.

Power hydraulics deliver 250 l/min. The turning circle is just 15.7 m.

#### Drilling and fertiliser application.

Get onto the field earlier in the spring and have enough capacity for high work rates.

#### Silo operations.

The impressive pushing power of the front linkage ensures optimal compaction on the silage clamp.







Our drive system: the perfect interplay between optimal components.

Your CLAAS machine is much more than the sum of its individual parts. Top performance is only possible when all parts are ideally matched and work together optimally.

In CLAAS POWER SYSTEMS (CPS), we have brought together top-quality components to create an intelligent drive system that sets new standards. Full engine output only when you need it. Drives that are suited to the way your machines are used. Fuel-saving technology which quickly pays off.

**CPS** | CLAAS  
POWER  
SYSTEMS



# Power where you need it.

## Impressive performance.

CLAAS POWER SYSTEMS combines powerful 6-cylinder Mercedes-Benz engines with a simple drive train. Enormous torque is available with all three machines even in lower engine speed ranges. The XERION 5000 delivers a maximum torque of 2,600 Nm when the PTO is switched on. The low-speed concept reduces the engine idling speed from 800 rpm to 730 rpm.

### 462 hp even in the XERION 4200.

We have increased the engine output of the XERION 4200 by 27 hp, so drivers can now enjoy more torque at lower engine speeds – as well as enhanced driving dynamics, large power reserves and reduced fuel consumption.

- 2,200 Nm maximum torque
- Smoother running
- More power and agility



### Designed to save fuel.

- Engine output of XERION 4200 increased by 27 hp to 462 hp
- Extremely powerful engines even in the low speed range
- Constant torque curve at high level
- Exhaust gas aftertreatment fully integrated without impeding visibility
- Intelligent cooling with fuel-saving fan speed control
- Radiators can be cleaned on the move by pressing a button to reverse the fan wheel

### Integrated exhaust gas aftertreatment.

- Stage V thanks to SCR technology, diesel particulate filter (DPF) and diesel oxidation catalyst (DOC)
- Tucked away under the cab

XERION		5000	4500	4200
Number of cylinders		6	6	6
Cubic capacity	cm <sup>3</sup>	12800	12800	10700
Output at nominal engine speed (ECE R 120) <sup>1</sup>	kW/hp	374/509	353/480	337/458
Max. output (ECE R 120) <sup>1</sup>	kW/hp	390/530	360/490	340/462
Max. torque (ECE R 120) <sup>1</sup>	Nm	2600	2400	2200

<sup>1</sup> Meets ISO TR 14396

### Latest generation of engines.

- 6-cylinder in-line Mercedes-Benz engines
- Maximum output from 462 to 530 hp
- Common rail injection and 24 V starter motor





# Continuously variable transmission for enhanced driving comfort.

Unique in this hp class.

The CMATIC continuously variable transmission from ZF is in a class of its own. From 0.05 to 50 km/h you have the benefit of outstanding driving comfort as well as efficient power transmission provided by a high mechanical component.

The linear drivetrain ensures that engine power reaches the axles and PTO by the most direct route. Selectable longitudinal and transverse differentials provide optimum power transfer.

The accelerator pedal and multifunction control lever are designed for simple and intuitive operation. During field work or at constant PTO speed the ground speed automatically adapts to the conditions. You can reduce fuel consumption noticeably by making simple adjustments to the engine droop settings.



### Short transfer times at 40 or 50 km/h.

The wheeled versions of the XERION can reach speeds of up to 30 km/h depending on the type of transmission. With the cab rotated, you can also travel backwards at up to 30 km/h.

### Standing firm.

The XERION slows to a stop as soon as the driver takes their foot off the accelerator. There is no need to apply the brakes – the tractor remains stationary.

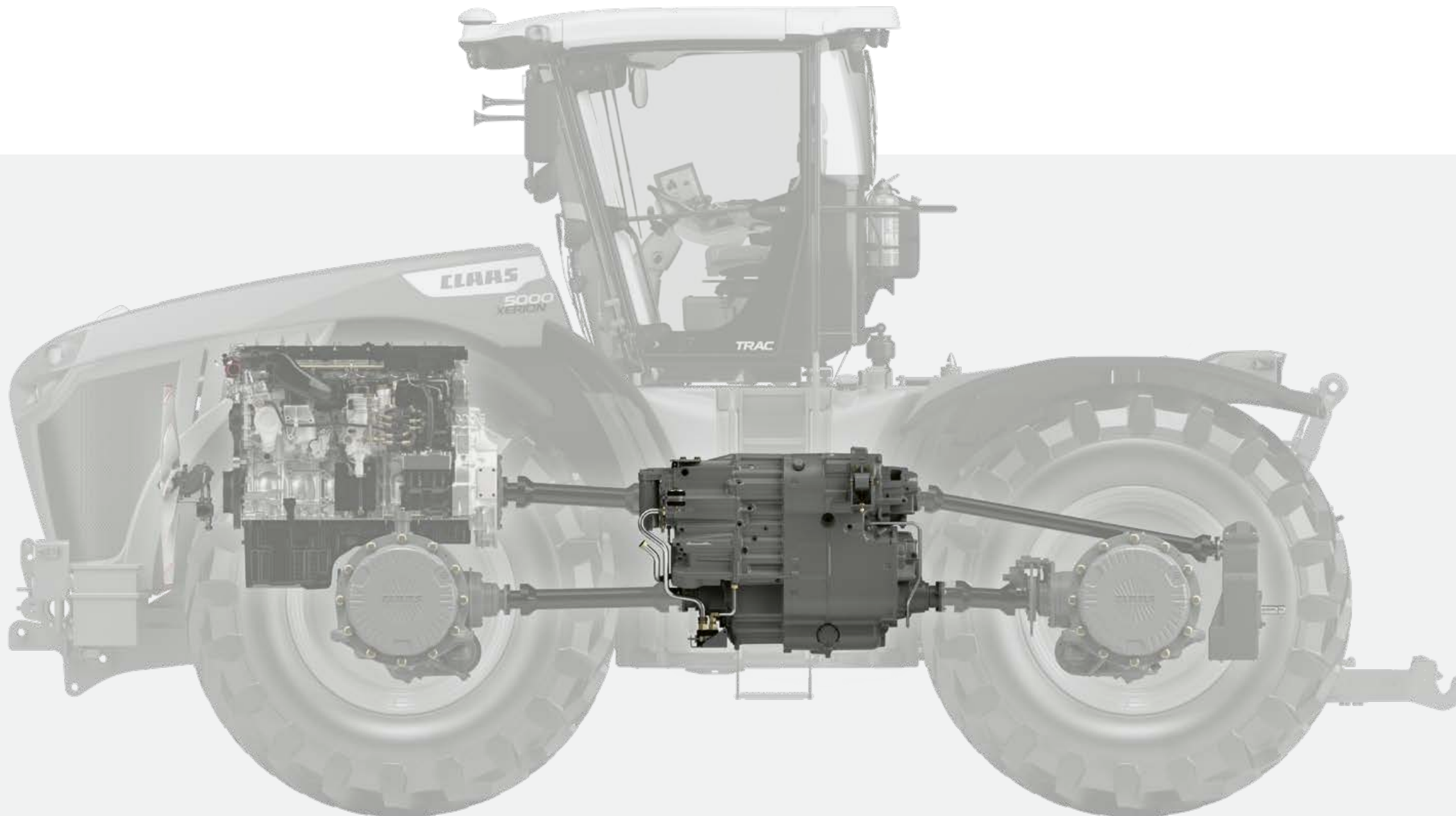

### Power equals efficiency.

- CMATIC transmission technology for continuously variable driving comfort from 0.05 to 50 km/h
- Linear drivetrain configuration for direct transfer of engine power
- Permanent four-wheel drive
- Four automatically activated driving ranges for high efficiency
- Large contact area for enormous tractive performance
- User-friendly operation via accelerator pedal or multifunction control lever



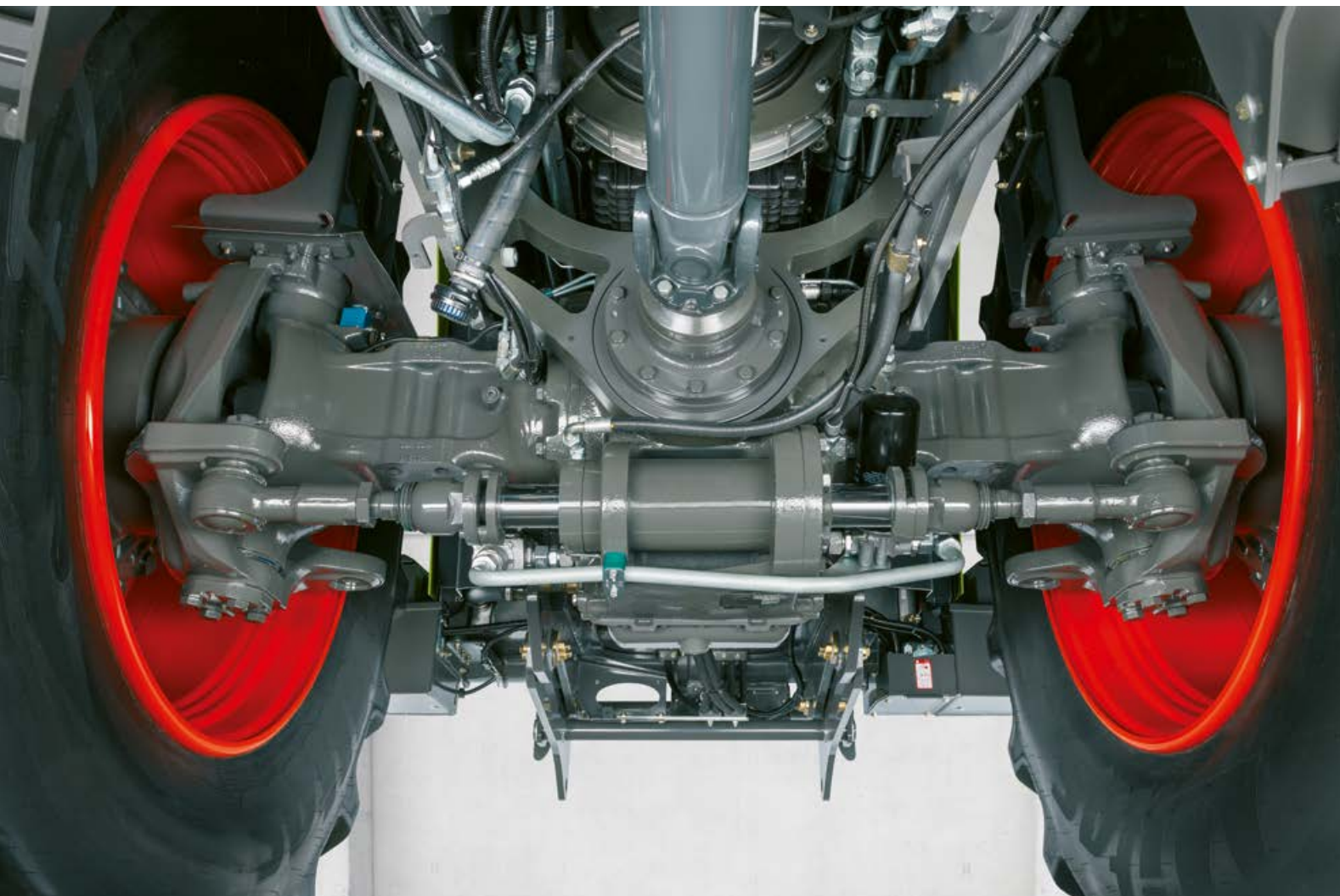

**Built for extreme loads.**

The XERION is ideal for carrying heavy loads thanks to its unique frame construction. Bolted rather than welded crossbeams in the frame provide greater strength and load-carrying capacity. The heavy-duty axles are designed to carry loads of up to 15 t per axle at speeds of up to 50 km/h. Despite its size and weight, with two steered axles the XERION is remarkably agile and manoeuvrable.

The 110 mm ball hitch for attaching large slurry tankers is located immediately behind the cab. It distributes the load of the attached tanker across both axles, while the long 3.6 m wheelbase provides a high level of driving comfort.

**Stability you can count on every day.**

- Durable, extremely robust full frame
- Heavy-duty axles with 15 t axle load up to 50 km/h
- Fully integrated linkage with load capacities of up to 8.4 t at the front and 13.6 t at the rear

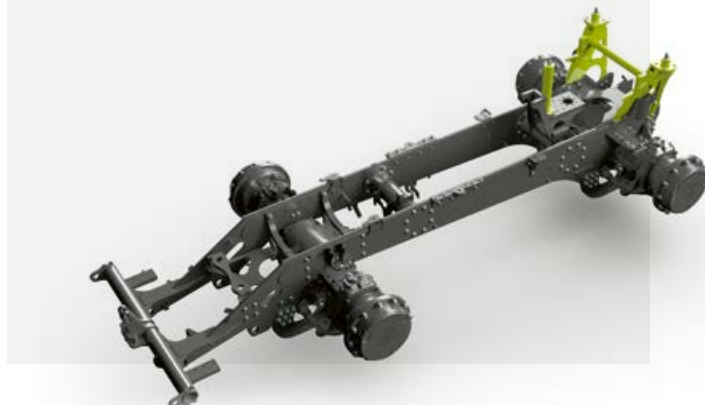

**1**

**Benefit:**  
High stability on the road

**Main applications:**  
On-road transport  
Field transport (transfer vehicle)

**2**

**Benefit:**  
Highly manoeuvrable

**Main applications:**  
Tillage  
Drilling

**3**

**Benefit:**  
Drift correction keeps tractor on track

**Main applications:**  
Tillage and drilling on a slope

**4**

**Benefit:**  
Protects the soil (no double rolling action)

**Main application:**  
Slurry spreading

**5**

**Benefit:**  
Maximum utilisation of contact surface

**Main application:**  
Silage clamp work

**The right steering for even job.**

The two steering axles on the XERION can be steered in five different ways, and remain active at the headland.

**1 Standard steering program.**

- Four-wheel and front-axle steering combined
- From 5° steering lock on the front axle, the rear axle follows the front axle electrohydraulically
- The steering lock is continuously reduced from 12 km/h
- Fully locked at 40 km/h

**DYNAMIC STEERING option.**

- The number of turns of the steering wheel needed to reach maximum wheel lock is significantly reduced according to the speed.
- More comfortable and dynamic turning at the headland

**2 Four-wheel steering.**

- Rear axle is steered at the same time as the front axle but in the opposite direction
- Axles move simultaneously

**3 Single-sided crab steering.**

- Rear axle controlled separately via the CMOTION multifunction control lever

**4 Gentle mode (reduced crab steering).**

- Rear axle moves along a parallel track to front axle
- 75% of steering lock can be used
- Steering corrected up to 4° by the steering wheel via the front axle

**5 Full crab steering.**

- Rear axle moves along a parallel track to front axle
- Rear axle steered once via the CMOTION multi-function control lever
- Minor steering corrections possible





Two power transmission options.

With the XERION you have two options for transferring its power to the ground via both axes: four equal-sized wheels, or dual tyres that double the contact area.



Four equal-sized wheels.

- Excellent soil protection and good ground-contour tracking
- With a diameter of 2.16 m
- Footprint approx. 3.7 m<sup>2</sup> with 900/60 R 42 tyres and 1 bar internal tyre pressure
- No more than 3 m wide with 710/75 R 42 and 750/70 R 44 tyres

- Comfortable road travel at up to 40 or 50 km/h
- Optional tyre pressure control system controlled via the CEBIS on-board information system
- Maximum traction and less slip
- Plenty of tractive power



Dual tyres.

- Dual tyres for a high level of soil protection
- Suitable for tyre dimensions 650/85 R 38, 710/70 R 42 and 710/75 R 42
- Rims on outer wheels are firmly bolted to the inner rims with spacer rings
- Split spacer rings allow for rapid removal of the outer wheels for road travel (< 3 m)



# Get the ballasting right for optimum efficiency.

## Fuel-efficient ballasting.

Tractors all too often carry too much weight. But over-ballasting does not boost tractive performance – it simply increases fuel consumption. With the XERION it's easy to adjust the ballasting precisely to suit the task. The 400 kg ballast plates can be quickly fitted or removed and firmly secured with quick-release fasteners.

### Front ballast.

You can add 3,400 kg of ballast to the front of the XERION. The base weight weighs 1,800 kg and can take up to four additional 400 kg plates. It is available in two versions: one that can be attached to the front linkage and one that is fixed permanently in place.

### Rear ballast.

The rear of the XERION can also be ballasted with 3,400 kg. A 1,000 kg fixed (but removable) base plate can accommodate six additional plates each weighing 400 kg. These can be quickly added or removed with a telehandler, wheel or front loader.

### Three ballasting tips.

- 1 As much as necessary, as little as possible
- 2 In the field, the need for ballasting decreases as the ground speed increases
- 3 During field work, tyre slip should average more than 6%, otherwise the tractor is carrying too much ballast

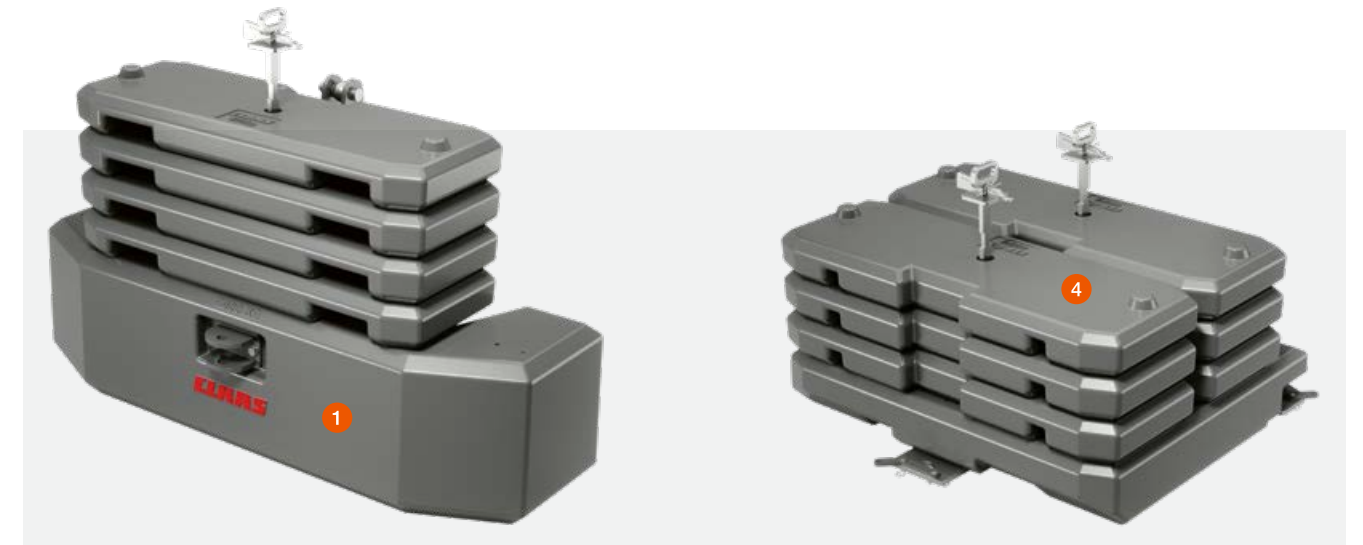

Variable front-mounted ballasting.

Rear ballasting up to 3,400 kg.

- 1 Base weight for the front linkage
- 2 Fixed base weight
- 3 400 kg modular plate
- 4 1,000 kg rear base plate



Max. ground speed under full load	Max. permitted vehicle weight (incl. drawbar load of attachment in t.)
8 km/h	24 t
10 km/h	22.5 t
12 km/h	18.5 t

It's a good idea to estimate in advance the speed at which you plan to work with the attached implement. For example, if you ballast for a speed of 8 km/h and then work at 12 km/h, you're carrying almost 6 t of excess ballast. This has a noticeable effect on fuel consumption.

### The right weight for every application.

- Add up to 3,400 kg of ballast at the front and the rear
- Weights are easy to add and remove
- All plates are held securely in place with a quick-release mechanism
- Get the ballast right and save fuel



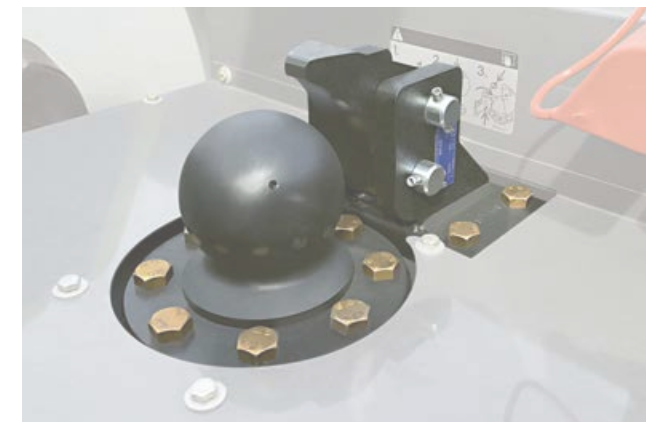

### Swan neck.

The swan neck coupling with its 110 mm hitch ball is designed to take a drawbar load of up to 15 t, which it distributes evenly across both axes. This type of hitch gives a smaller turning radius and a much shorter combination length than a tractor with a rear-mounted slurry tanker, for example.

### Different drawbar hitches.

With drawbar hitches you have a choice of an 80 mm hitch ball or 38 and 50 mm diameter pin. With three holes, you can vary the position of the attachment point. So whatever the application, you can always maintain the right distance from the rear axle.

### Hitch points and PTO for heavy loads.

With the XERION you can choose from a range of hitching options. Whether swan neck attachment, drawbar or trailer coupling, all systems are designed for high load-carrying capacity.

When the PTO is running at 1,000 rpm, the XERION develops its output at a reduced engine speed of 1,730 rpm. Thanks to the simple drive train design, much of the rated output is transferred to the PTO stub. This enables you to reduce your fuel consumption even when the XERION makes the full PTO output available.

### Rest assured.

- All hitching systems are designed for high load-carrying capacity
- The swan neck hitch can take a drawbar load of up to 15 t
- The PTO provides full power even at reduced engine speed
- The PTO stubs can be replaced quickly and easily
- You have a choice of different drawbars with:
  - a 40 or 50 mm diameter locking pin
  - an 80 mm hitch ball
  - a Piton-Fix coupling



### High drawbar loads.

The XERION can take on any challenge. With the range of hitch options, it can take a drawbar load of up to 5 t.

- D50 pins (Ø 50 mm)
- D70 pins (Ø 70 mm)

### Quick-change PTO stubs.

The PTO stubs can be replaced quickly and securely. Choose from the following sizes:

- 1 3/4", 6 splines
- 1 3/4", 20 splines
- 2 1/4", 22 splines (Ø 57.7 mm)



# Untap its full potential.



Hydraulic output of up to 442 l/min.

The XERION provides ample hydraulic power for special applications such as digestate spreading. The hydraulic circuits can be controlled via the CMOTION multifunction control lever. You can assign all ten function buttons to individual hydraulic functions.

The XERION has a new pump transfer gearbox to satisfy even higher hydraulic requirements. A hydraulic pump with an output of 197 l/min is mounted to the pump transfer as standard. A second hydraulic pump (load sensing) supplies a further 225 l/min for the four, five or six spool valves. And of course the proven additional power hydraulic system with a separate circuit delivering with 250 l/min is optionally available for attachments such as liquid manure tanks.

### Power Beyond at front and rear.

Power Beyond connections with large-diameter lines, flat-seal hydraulic couplings and hydraulic return line provide a high oil delivery rate with low losses.

The XERION has three double-acting spool valves at the front (max. two spool valves if a front linkage is installed). Seven further double-acting spool valves are available at the rear. With quick-release couplings, you can connect and disconnect them rapidly without risk of oil leaks.

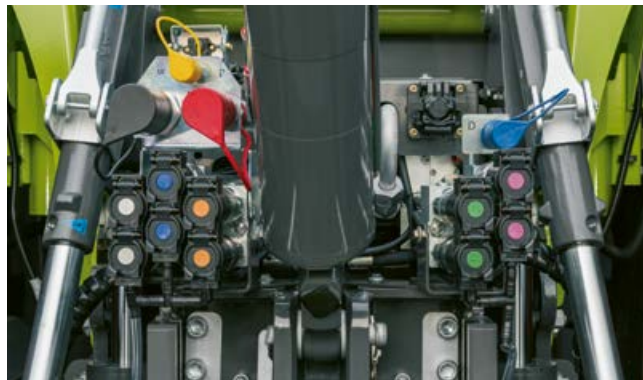
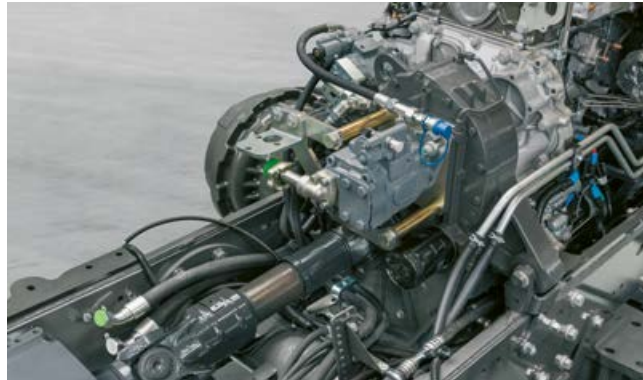

### Enough pressure.

- Three hydraulic circuits supply your attached or mounted implements reliably and powerfully
- Up to ten double-acting spool valves available at the front and rear
- The new pump transfer gearbox mounted on the engine enables hydraulic outputs of up to 442 l/min
- Strong power hydraulics perform convincingly even at low engine speeds
- Power Beyond connections with large-diameter lines maximise flow
- Conveniently controlled via the CMOTION multifunction control lever





## Power enough for any job.

With an enormous continuous lift capacity of 8.1 t at the front and 10 t at the rear, the XERION handles even very heavy implements effortlessly.

With the CMOTION multifunction control lever you can control the front and rear linkage easily with your thumb without having to move your hand. This high level of operating comfort means that on long working days you can work quickly and accurately without tiring.

## Equipped for any challenge.

- Continuous 8.1 t lift capacity at the front and 10 t at the rear
- Vibration damping for safe and comfortable working
- Reinforced front linkage for silage clamp work
- Pivoting rear linkage for the SADDLE TRAC (optional)
- Convenient control via the CMOTION multifunction control lever



## 8.1 t lift capacity at the front.

The sturdy front linkage (1) is fully integrated into the frame. The lower links fold in easily to reduce the vehicle length.

- Double-acting ram with continuous 8.1 t lift capacity
- Quick and easy to attach front weights



When using the TRAC, TRAC VC or SADDLE TRAC in the silage clamp, you can fit a reinforced front linkage (2) which can accommodate a dozer blade up to 4.0 m wide. Shear bolts protect the linkage from damage.



## 13.6 t lift capacity at the rear.

The rear linkage (3) is equipped with vibration damping and category IV N hooks. For the top attachment point on the 3-point hitch at the rear, you can choose from a mechanical or hydraulic top link.

- Double-acting rams with max. 13.6 t (10 t continuous) lift capacity
- Hydraulic side stabilisers with a high level of operator comfort
- Mechanical side stabilisers or internal reinforcement
- Robust ball ends for extended periods working with the same implement (optional)



A pivoting rear linkage (4) is available for the SADDLE TRAC. This allows you to use a low-compaction offset mode, for example when spreading slurry on sensitive grassland areas.



You've got a long day's work ahead.

So make yourself at home.

The more comfortable you feel at the wheel, the more productive you will be at work. That's something all drivers agree on. For the new XERION, we have taken on board many suggestions from professionals; more comfortable seats, heated windows all the way round and intelligent assistance systems are a given. The armrest with integrated CEBIS touchscreen and ergonomic CMOTION multifunction control lever ensures your hand is in a comfortable position, with all functions at your fingertips. Furthermore, the CEMIS 1200 terminal supports you with precision guidance, ISOBUS applications and job documentation.

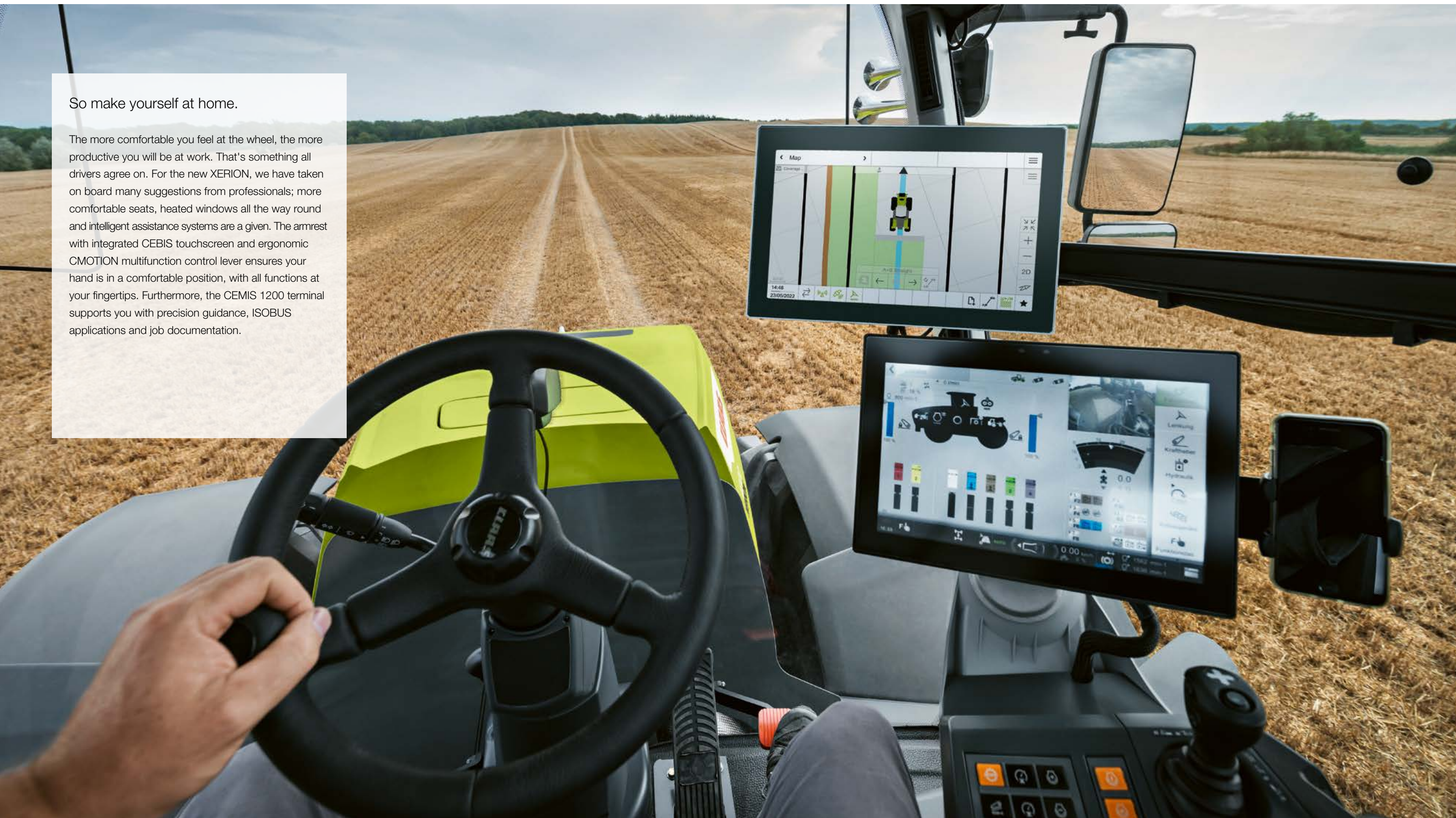





The TRAC VC has the most convenient reverse-drive system on the market. Its cab can be rotated through 180° in less than 30 seconds.



With 22 work lights, the XERION turns night into day. A premium LED lighting package is available on request.

**Comfortable, clearly laid out and quiet.**

We have designed the XERION cab so there is nothing to distract you. Virtually no vibrations, exceptional all-round visibility, pleasantly low noise levels. With the CMOTION multifunction control lever and the armrest with integrated CEBIS touchscreen, you can control the tractor intuitively with just three fingers. The new CEMIS 1200 terminal is also within easy reach.

**The XERION comfort cab.**

- Generously sized cab
- Large, heated windows for a perfect all-round view
- Outstanding sound proofing (only 69 dB max.)
- Intelligent semi-active cab suspension
- Rotating cab provides the most convenient reverse-drive system on the market (TRAC VC)
- Intuitive CMOTION multifunction control lever
- 12" CEBIS monitor with touchscreen
- CEMIS 1200 terminal with intuitive user interface
- 3-way adjustable steering column
- Air conditioning and auxiliary heating
- 360 degree windscreen wiper on the front windscreen

- Sun blinds on all four sides (optional)
- Lights activated from the steps

**It's got everything you need to make your job easier.**

- Comfortable swivel seat – with optional leather cover
- Heated windows for good visibility whatever the weather
- Armrest with integrated CEBIS touchscreen for efficient operation
- Intuitive CEMIS 1200 terminal for precise guidance and documentation



We've listened to our drivers.

We worked with our customers and drivers to develop the control concept specifically for large CLAAS tractors. The driver's arm and hand stays in a relaxed position without tiring. The clearly arranged control and function buttons are labelled with self-explanatory symbols.

### Three-finger operation.

The CMOTION multifunction control lever allows you to control complex processes with up to four control functions intuitively using only your thumb, index and middle finger – so you can work in comfort with your hand resting in a natural position.

### Everything under control with CEBIS.

The height-adjustable armrest incorporates the 12" CEBIS touchscreen which allows you to navigate the main and sub-menus with ease. All operating states are clearly displayed and you can adjust the machine settings in just a few steps.



### 1 CEBIS touchscreen.

You can choose between two screen layouts (road or field), each with self-explanatory symbols and colour coding. The DIRECT ACCESS function with the machine silhouette gives you rapid access to the sub-menus. A high-resolution camera helps you to work with inch-perfect precision.

### 2 CEBIS rotary pushbutton.

Use it to navigate the CEBIS menu reliably even on bumpy ground. The DIRECT ACCESS button takes you straight to the last activated tractor functions.

### 3 Clearly laid-out control panel.

Use the self-explanatory controls to operate the basic functions. For example, you can switch the PTO or differential lock on or off, control the linkage or position the front and rear linkage.

### 4 CMOTION multifunction control lever.

The ergonomic CMOTION multifunction control lever makes light work of complex operations at the headland.

### All machine functions at a glance.

- Intuitive control concept for efficient work
- Rapid CEBIS navigation via touchscreen or rotary pushbutton
- CMOTION multifunction control lever for three-finger control of the machine
- Clearly laid out controls with self-explanatory symbols
- CEMIS 1200 terminal for efficient precision farming

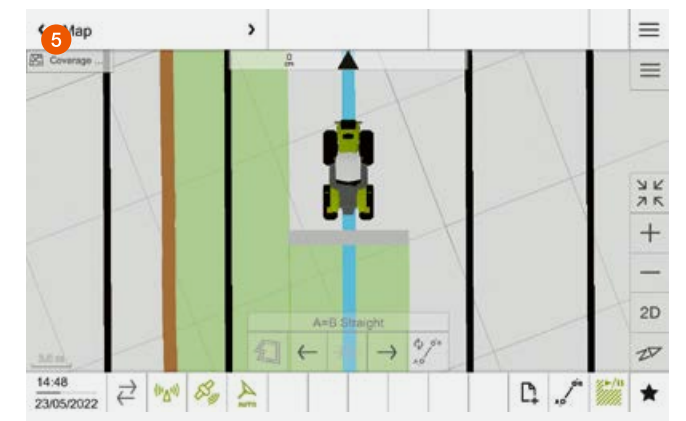

### 5 Intuitive CEMIS 1200 terminal.

The CEMIS 1200 terminal fits seamlessly into the cab and shares the same intuitive control logic as CEBIS, so you'll soon find your way around. You can use the system on all CLAAS machines set up for GPS PILOT CEMIS 1200, and transfer the terminal and receiver from one machine to another in next to no time.

- Intuitive user interface for outstanding ease of use day and night
- Quick access to all important functions
- Freely configurable working areas for custom control
- Easy activation of new functions allows you to respond flexibly to changing requirements
- Transfer new licences online or activate directly on the terminal
- Automatic section switching with ISOBUS TC Section Control for precise, stress-free work
- Precision farming and documentation with ISOBUS TC-GEO and VRA
- Rapid transfer of all task data via mobile phone connection



## Digitalisation is indispensable.

There are very good reasons for the digitalisation of our machines – three to be precise: we want to help your operators work more confidently, make your work go more smoothly and reduce your costs. With self-learning operator assistance systems, for example, or steering systems that are accurate down to the last centimetre. And with data management that meaningfully connects your systems, machines and work processes.





# Perfect turning manoeuvres in next to no time.

## CLAAS SEQUENCE MANAGEMENT (CSM).

CSM headland management takes the load off the driver when manoeuvring at the headland. Any previously recorded functions can be run simply by pressing a button.

The following functions can be combined in any order:

- Spool valves with time and flow control
- Four-wheel drive, differential lock and front axle suspension
- Front and rear linkage
- Cruise control
- Front and rear PTO
- Engine speed memory



With CEBIS	
Number of storable sequences	Four per implement, up to 20 implements
Sequence activation	CMOTION and F buttons
Sequence display	On CEBIS display
Recording mode	Time- or distance-related
Edit function	Subsequent sequence optimisation in CEBIS



Activate the sequence using the F buttons on the CMOTION control lever.

### Take it easy at the headland.

- CSM automates your turning manoeuvres
- You can record, vary, optimise and automatically run up to four sequences

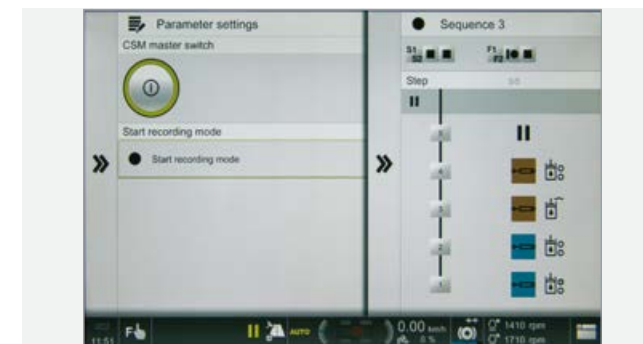

### Easy to record and run.

Sequences can be recorded on a distance- or time-related basis. In recording mode, clear symbols guide the driver step-by-step through the process of creating the sequence on the CEBIS. A sequence that is running can be paused and restarted simply by pressing a button.

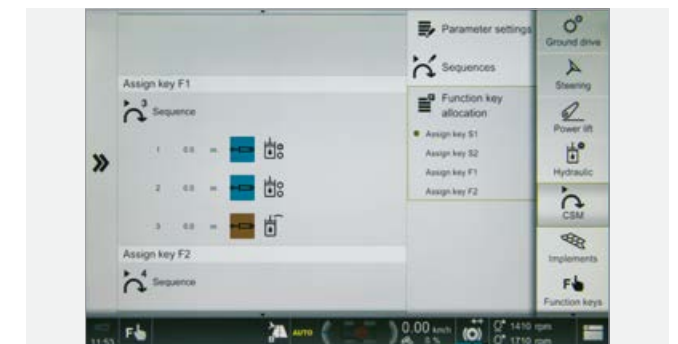

### Non-stop optimisation with CEBIS.

Recorded sequences can be changed and optimised in CEBIS at a later date. Steps can be added and deleted or changed and adapted in minute detail, allowing times, distances and flow volumes to be tailored to current conditions. Once a sequence has been recorded, it can be refined down to the last detail in just a few steps.



# Always on the right track. The CLAAS steering system.

The CLAAS steering system increases work quality.

CLAAS steering systems take the pressure off the driver. They show in advance which direction to take, or automatically steer the tractor along the best possible path. Studies show that a modern parallel guidance system can save up to 7% on fuel, machine costs, fertiliser and crop protection products by eliminating mistakes and overlaps. With the GPS PILOT CEMIS 1200, the terminal guides you into the future. Tailor-made for your farm, it assists you with precise GPS tracking and task documentation.

### GPS PILOT with high steering precision.

The satellite-based automatic steering system from CLAAS is permanently integrated in the machine. It simplifies any task which requires high pass-to-pass accuracy. You start the GPS PILOT via the multifunction lever. It actively controls the steering hydraulics and guides you across the field precisely at all speeds, regardless of the light conditions. It works at night or in low visibility just as precisely as it does in full daylight. You receive correction signals for whichever degree of accuracy you require.

### Flexible functionality.

You can easily adapt the system's functions to suit your changing needs. The appropriate licence or activation can be transferred online straight to your terminal. For example, via CEMIS 1200 you can switch sections on or off automatically with ISOBUS TC Section Control or carry out site-specific applications with ISOBUS TC-GEO and VRA. You can choose to have the ISO UT implement view displayed in the main screen of the CEMIS 1200 or in one of the three smaller screens.

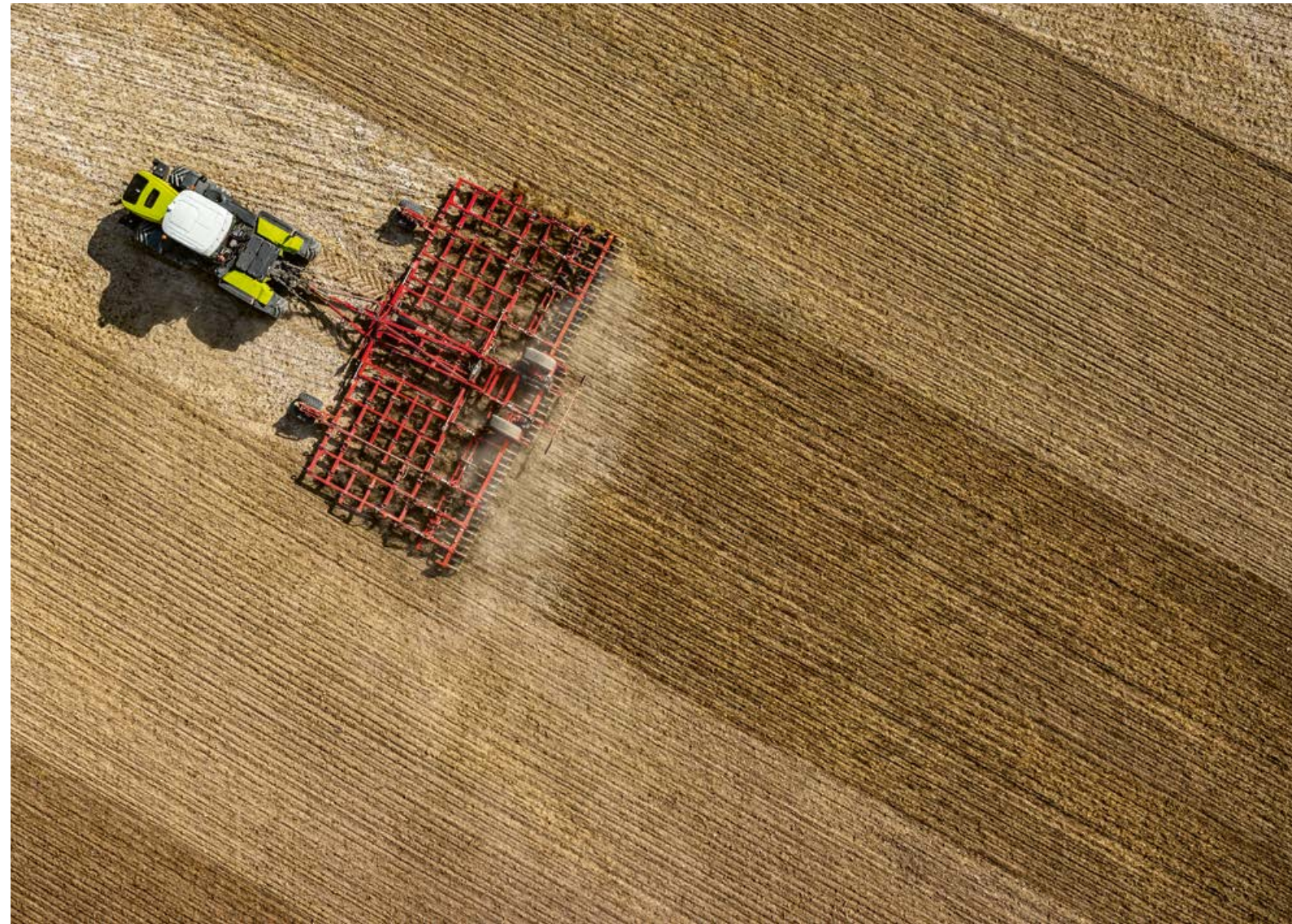

### CEMIS 1200 terminal with intuitive control.

The new CEMIS 1200<sup>1</sup> ISOBUS terminal supports you reliably with precision farming applications such as automatic steering, site-automatic section and rate control, and precise task documentation. The design, graphics and control interface are based on CEBIS, so you'll soon find your way around the system.

- The high-resolution 12" screen displays all key information
- Working areas and views are freely configurable
- QUICK ACCESS enables rapid, direct access to key functional areas and menus

### Flexible options for correction signals.

We have designed our range so that you can extend your system easily at any time. This applies just as much to the terminal technology as to the use of all major correction signals. We can currently work with all available satellite systems – GPS, GLONASS, BEIDOU and Galileo

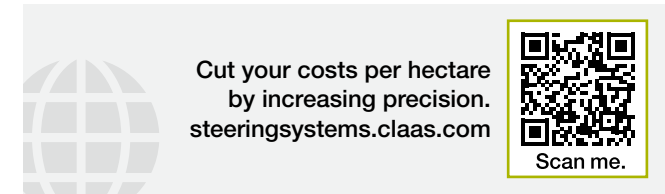

### RTK NET (accuracy ± 2-3 cm)

- Correction signal via mobile phone network
- Unrestricted working radius

### RTK FARM BASE LINK (accuracy ± 2-3 cm)

- Base station
- Station data transmitted via mobile phone network (NTRIP)
- Operating radius 30 km

### RTK FARM BASE (accuracy ± 2-3 cm)

- Base station with digital and analog radio can be used
- Range up to 15 km

### SATCOR by Trimble RTX

- Satellite-based correction signal from CLAAS
- Virtually worldwide coverage

#### SATCOR 15 by Trimble RTX (accuracy ± 15 cm)

- Improved basic accuracy
- Quick signal availability
- Good signal suitable for many applications from soil cultivation to harvesting

#### SATCOR 3 by Trimble RTX (accuracy ± 3 cm)

- Ideal in areas where RTK and mobile phone coverage is patchy
- Longer initialisation period than SATCOR 15 but more accurate

#### SATCOR 3 FAST by Trimble RTX

- Initiation time less than 2 minutes
- Genuine alternative to RTK correction signals
- Coverage in Europe and the USA

### EGNOS (accuracy ± 30 cm)

- No licence fee
- Base accuracy

<sup>1</sup> Not available for SADDLE TRAC.



# A connected XERION is more productive.

## Digitalisation pays.

Digitalisation is a key factor in increasing your productivity and efficiency. Data generated in completely different places can be collected and evaluated centrally. This conserves your resources and improves your business processes.

To enable you to get more out of the XERION and your other machines, CLAAS offers a range of modules which allow systems, technology and working processes to be connected with each other, regardless of the manufacturer. Intelligent digitalisation matched to the requirements of your farm can reduce your workload significantly.

- Transfer and document machine and job data quickly
- Manage individual machines and the whole fleet efficiently
- Analyse working processes carefully and optimise them
- Analyse fields easily and map yields precisely
- Call up and manage farm data with intelligent farm management software
- Transmit data from different manufacturers' machines to TELEMATICS smoothly
- Save valuable maintenance and service time with remote diagnostics



Connect your machines.  
Optimise your jobs.

[connected-machines.claas.com](http://connected-machines.claas.com)

Scan me.



## TELEMATICS records your success.

With TELEMATICS you can continuously retrieve and record work and performance data for your tractor. All data are transmitted via the mobile phone network from the machine to the server, where they are processed and stored. You can access and evaluate your data online in real time or retrospectively via the web portal or the TELEMATICS app. The Connected Documentation licence amalgamates all the data on a field-specific basis in the background. It is also possible to export your data to any current farm management software program.

## CLAAS API connects your office to your fleet.

With the DataConnect function, CLAAS, 365FarmNet, John Deere, Case, Steyr and New Holland have created a direct, multi-manufacturer, industry-wide and open cloud-to-cloud solution. This allows you to control and monitor your entire machinery fleet in the CLAAS TELEMATICS portal – safe in the knowledge that all relevant data are exchanged securely, conveniently and fully automatically. Both systems are components of CLAAS TELEMATICS.

## Remote Service costs you nothing.

Remote Service from CLAAS is an important machine networking element. It simplifies maintenance and service support significantly. The machine informs the service partner of an upcoming requirement for maintenance or sends immediate notification if a fault arises. The service partner has access to the relevant data and can prepare optimally for the intervention in both scenarios. CLAAS covers the cost of Remote Service for you during the first five years. All you have to do is give your consent.

## NEW: CEMIS 1200 manages your jobs.

With CEMIS 1200 and an active Connected Documentation licence, you can take care of your task management online with just a few clicks. Plan your tasks in your farm management software and transfer them to the machine via TELEMATICS. The operator has all the tasks in sight and can quickly and easily send them back to the office on completion. With ISOBUS TC-GEO you can easily document geo-referenced data such as application rates. VRA (Variable Rate Application) is the module you need for site-specification application.

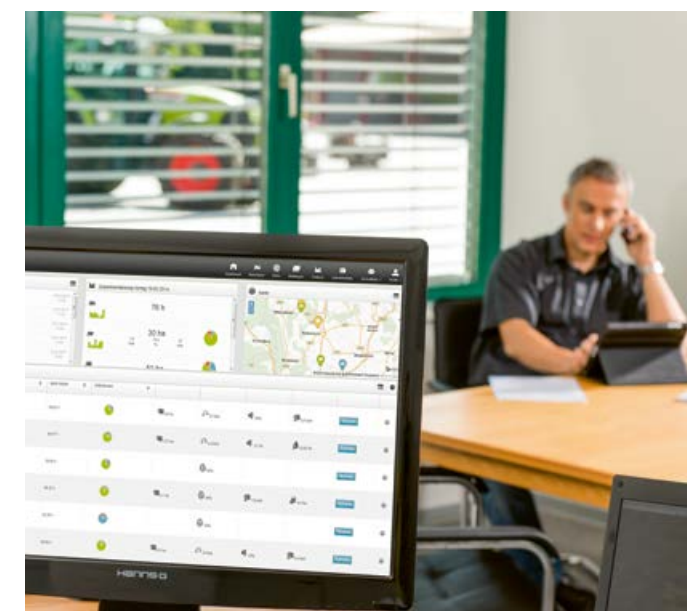

## Digitalisation puts your farm ahead.

- TELEMATICS transfers your data from your machine straight to the cloud
- With CEMIS 1200 you create and manage all jobs on the spot in the machine
- DataConnect allows you to process data from your machines, regardless of manufacturer
- Remote Service simplifies maintenance and service support





### One-piece bonnet.

The one-piece bonnet provides rapid access to all maintenance points. Four easily removable side panels provide additional access.

### Easy access.

The engine oil filter is positioned within the full frame for easy access. You can access the coolant reservoir when the bonnet is closed. The batteries are safely installed at the front.

### Double the maintenance interval.

We have raised the bar: the XERION need only go to the workshop for engine servicing once every 1,000 hours. Doubling the servicing interval results in significant cost savings.

### A XERION is economical.

The machine does whatever it can to minimise downtimes. The engine needs servicing just every 1,000 hours. And CEBIS tells you when.

### Simple radiator cleaning.

When maintenance does become due, it can be carried out quickly and effortlessly. The engine oil filter and cab air filter are very accessible. The radiator assembly can easily be opened and cleaned by the driver as required.

What's more, at the press of a button the driver can reverse the direction of the fan from the cab to blow dust and dirt away from the radiators in seconds.

### Clean engine intake air.

The XERION has an efficient system for precleaning the engine intake air. Cyclones separate out the coarse dirt which is then removed by the exhaust system. The PowerCore® engine air intake filter is extremely robust with high filtration performance.

### Maintenance maintains the value.

- 1,000 hour engine service interval
- One-piece bonnet for rapid access to all maintenance points

- Coolant reservoir can be accessed when the bonnet is closed
- PowerCore® filter for cleaning the engine intake air
- Batteries safely protected



Whatever it takes.  
CLAAS Service & Parts.



CLAAS Service & Parts  
is there for you 24/7.  
[service.claas.com](http://service.claas.com)

Scan me.



**Safeguard your machine's reliability.**

Increase your operating reliability, minimise the risk of breakdown and repair. MAXI CARE offers you predictable costs. Create your own individual service package to meet your particular requirements.

**Remote Service.**

With Remote Service, all the relevant data from your telematics-equipped machines are made available to your service partner. This greatly simplifies the remote diagnostic process and the provision of remote support. Servicing can be carried out more efficiently and the level of machine readiness for use is enhanced. Remote Service is provided to you free of charge for a period of five years. All you have to do is give your consent.



**Specially matched to your machine.**

Precision-manufactured parts, high-quality consumables and useful accessories. Choose our comprehensive product range to be certain of receiving exactly the right solution to ensure 100% operating reliability for your machine.



**For your business: CLAAS FARM PARTS.**

CLAAS FARM PARTS offers one of the most comprehensive ranges of multi-brand parts and accessories for all agricultural applications on your farm.



**Global supply.**

The CLAAS Parts Logistics Center in Hamm, Germany, stocks almost 200,000 different parts and has a warehouse area of over 183,000 m<sup>2</sup>. This central spare parts warehouse delivers all ORIGINAL parts quickly and reliably all over the world.



**Your local CLAAS distributor.**

Wherever you are, you can count on us to always provide you with the service and the contact people you need. Your CLAAS partners are on hand in your local area, ready to support you and your machine around the clock. With know-how, experience, commitment and the best technical equipment. Whatever it takes.



# The new XERION: built to impress.



## The new generation.

- More performance: the entry-level XERION 4200 now delivers 462 hp and the XERION 5000 530 hp
- More comfort: the CEBIS touchscreen is built into the specially developed armrest
- More time in the field: the new 1,000 hour maintenance interval cuts servicing costs by up to 38%
- More accuracy: CEMIS 1200 terminal for efficient precision farming

## Proven design concept.

- Four equal-sized wheels or dual tyres convert engine power into tractive power
- Full-frame construction can carry enormous loads of up to 15 t per axle at 50 km/h
- Two steered axles offer five steering modes for a wide range of applications
- CMATIC continuously variable transmission helps to save fuel

## Powerful drive.

- Powerful 6-cylinder engines are combined with a simple drive train
- Full torque from 1,000 rpm
- Idling speed reduced to 730 rpm in parked position
- Maximum 1,700 rpm required for heavy tillage work
- All engines have SCR technology, particulate filters and diesel oxidation catalyst in compliance with Stage V

## Unrivalled comfort.

- The spacious cab offers excellent all-round visibility and sound proofing
- The rotating cab in the TRAC VC is the most convenient reverse-drive system on the market
- The CMOTION multifunction control lever and CEBIS 12" touchscreen are designed for intuitive operation
- GPS steering system and the CLAAS satellite-based correction signal SATCOR reduce the driver's workload

XERION		5000 TRAC / TRAC VC	4500 TRAC / TRAC VC	4200 TRAC / TRAC VC / SADDLE TRAC
<b>Engine</b>				
Manufacturer		Mercedes-Benz	Mercedes-Benz	Mercedes-Benz
Number of cylinders		6	6	6
Cubic capacity	cm <sup>3</sup>	12800	12800	10700
Nominal engine speed	rpm	1900	1900	1900
Lower engine idling speed (gear in neutral)	rpm	730	730	730
Upper engine idling speed	rpm	1920	1920	1920
Output at nominal engine speed (ECE R 120) <sup>1</sup>	kW/hp	374/509	353/480	337/458
Max. output (ECE R 120) <sup>1</sup>	kW/hp	390/530	360/490	340/462
Max. torque (ECE R 120) <sup>1</sup>	Nm	2600	2400	2200
Fuel tank	l	740	740	740
Auxiliary tank (190 l)		●	●	○
Urea tank	l	88	88	88

<b>Electrical system</b>				
AC generator	A/V	100 A / 24 V + 240 A / 12 V	100 A / 24 V + 240 A / 12 V	100 A / 24 V + 240 A / 12 V
Batteries	Ah/V	4 x 75 Ah, total 150/24, 150/12	4 x 75 Ah, total 150/24, 150/12	4 x 75 Ah, total 150/24, 150/12
<b>CMATIC transmission</b>				
Transmission		CMATIC	CMATIC	CMATIC
Transmission type		Hydrostatic-mechanical, split-power		
Output		Four-wheel drive, permanent	Four-wheel drive, permanent	Four-wheel drive, permanent
Max. speed	km/h	50/40	50/40	50/40
Longitudinal differential		Eccom 5.5: rigid (without longitudinal differential)		
PTO speed	rpm	1000	1000	1000
Automatic PTO engagement / disengagement		●	●	●

<b>Powered steering axles</b>				
Differential locks		100% lockable, electrohydraulic actuation, lamella construction, with automatic function		

<b>Brakes</b>				
Service brake		Hydraulically actuated wet multi-disc brakes, auxiliary-power-reinforced, acting on all wheels		
Parking brake		Electrohydraulically released spring-loaded brake		

<b>Hydraulics</b>				
Max. hydraulic tank capacity	l	120	120	120
Max. drawable volume	l	80	80	80

<b>Main circuit (linkage, auxiliary spool valves)</b>				
Max. operating pressure	Mpa (bar)	20 (200)	20 (200)	20 (200)
Max. flow rate	l/min	197	197	197
Number of spool valves		Max. 7 rear, max. 3 front	Max. 7 rear, max. 3 front	Max. 7 rear, max. 3 front
Max. flow rate per spool valve	l/min	105	105	105
Max. hydraulic output, total	kW	58	58	58

<b>Power hydraulics (optional)</b>				
Operating pressure	Mpa (bar)	26 (260)	26 (260)	26 (260)
Max. flow rate	l/min	250 at 1650 rpm	250 at 1650 rpm	250 at 1650 rpm SADDLE TRAC: 250 at 1480 rpm
Max. hydraulic output, total	kW	90	90	90

<b>Auxiliary hydraulics (optional)</b>				
Operating pressure	Mpa (bar)	20 (200)	20 (200)	20 (200)
Max. flow rate	l/min	80	80	80

<sup>1</sup> Meets ISO TR 14396

XERION		5000 TRAC / TRAC VC	4500 TRAC / TRAC VC	4200 TRAC / TRAC VC / SADDLE TRAC
<b>Hitches</b>				
Automatic hitch, D38 pin, spherical	max. kg	Drawbar load 2500	Drawbar load 2500	Drawbar load 2500
Hitch with hitch ball, ball system 80				
up to 40 km/h	max. kg	Drawbar load 3000	Drawbar load 3000	Drawbar load 3000
up to 50 km/h	max. kg	Drawbar load 2000	Drawbar load 2000	Drawbar load 2000
D40, D50 variable drawbar	max. kg	Drawbar load 3000	Drawbar load 3000	Drawbar load 3000
Drawbar ball system	max. kg	Drawbar load 4000	Drawbar load 4000	Drawbar load 4000
Hitch ball for swanneck hitching	max. kg	Drawbar load 15000	Drawbar load 15000	Drawbar load 15000
Piton Fix	max. kg	Drawbar load 4000	Drawbar load 4000	Drawbar load 4000

<b>Front linkage</b>				
Category	Mpa (bar)	III N, double-acting	III N, double-acting	III N, double-acting
Continuous lift capacity	kg	8100	8100	8100
Max. lift capacity	kg	8400	8400	8400
Max. lifting range	mm	905	905	905
Selectable function		Raise, lower (press)	Raise, lower (press)	Raise, lower (press)
Control function		Position control, vibration damping	Position control, vibration damping	Position control, vibration damping

<b>Rear linkage</b>				
Category		IV N, double-acting	IV N, double-acting	IV N, double-acting
Continuous lift capacity / max. lift capacity / max. lift range	kN / kN / mm	100 / 136 / 763	100 / 136 / 763	100 / 136 / 763
Selectable function		Raise, lower (press)	Raise, lower (press)	Raise, lower (press)
Control function		Position control / draught control, vibration damping	Position control / draught control, vibration damping	Position control / draught control, vibration damping

<b>Dimensions and weights for TRAC and TRAC VC</b>				
Overall length including linkages (front retracted, rear horizontal)	mm	7163	7163	7163
Overall height depending on tyres	mm	3791 to 3941	3791 to 3941	3791 to 3941
Wheelbase	mm	3600	3600	3600
Ground clearance depending on equipment	mm	375 to 525	375 to 525	375 to 525
Smallest turning circle	m	15	15	15
TRAC tare weight (with tyres, full tank and standard equipment)	kg	16300	16300	16000

<b>Dimensions and weights for SADDLE TRAC</b>				
Overall length including linkages (front retracted, pivoting rear linkage horizontal)	mm	7884	7884	7884
Overall height depending on tyres	mm	3900	3900	3900
Wheelbase	mm	3600	3600	3600
Ground clearance depending on equipment	mm	–	–	375 to 525
Smallest turning circle	m	–	–	15
SADDLE TRAC tare weight (with tyres, full tank and standard equipment)	kg	–	–	15600

CLAAS continually develops its products to meet customer requirements. This means that all products are subject to change without notice. All descriptions and specifications in this brochure should be considered approximate and may include optional equipment that is not part of the standard specifications. This brochure is designed for worldwide use. Please refer to your nearest CLAAS dealer and their price list for local specification details. Some protective panels may have been removed for photographic purposes in order to present the function clearly. To avoid any risk of danger, never remove these protective panels yourself. In this respect, please refer to the relevant instructions in the operator's manual. All technical specifications relating to engines are based on the European emission regulation standards: Stage. Any reference to the Tier standards in this document is intended solely for information purposes and ease of understanding. It does not imply approval for regions in which emissions are regulated by Tier.



Built to impress.

TRAC / TRAC VC

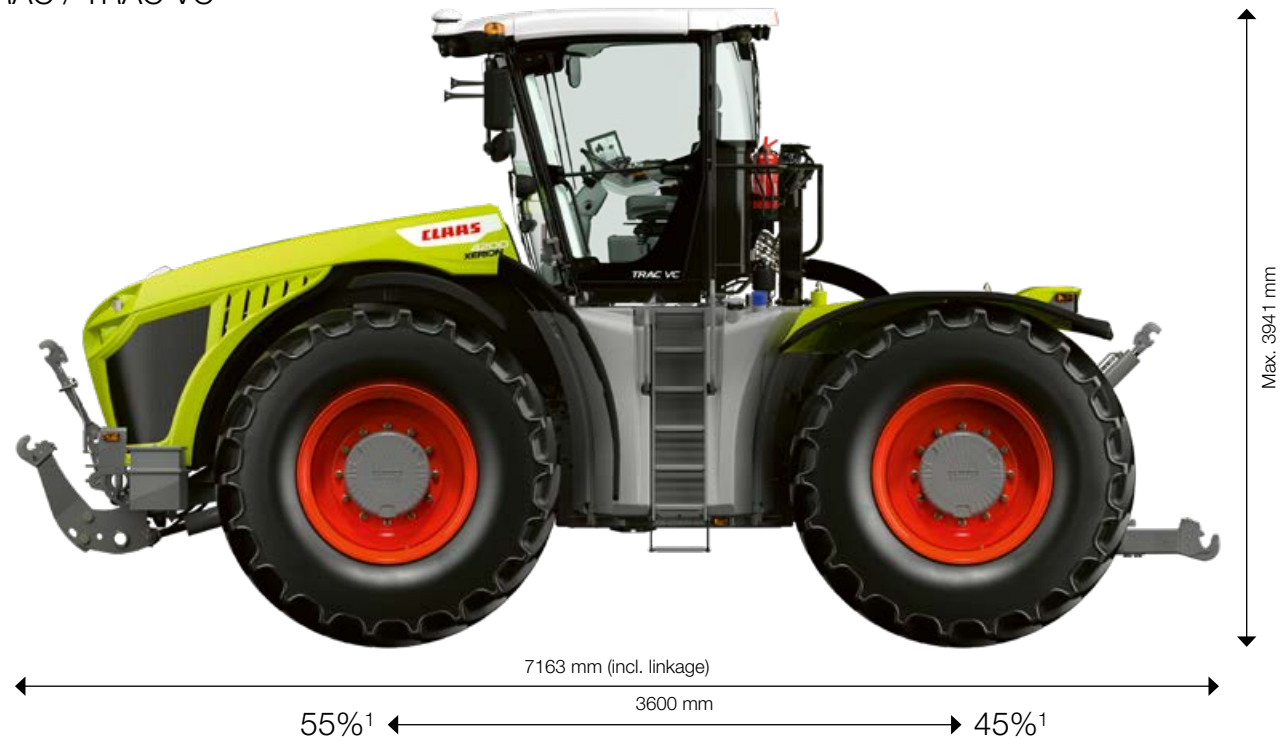

<sup>1</sup> Long wheelbase and balanced weight distribution for more tractive and lifting power

SADDLE TRAC

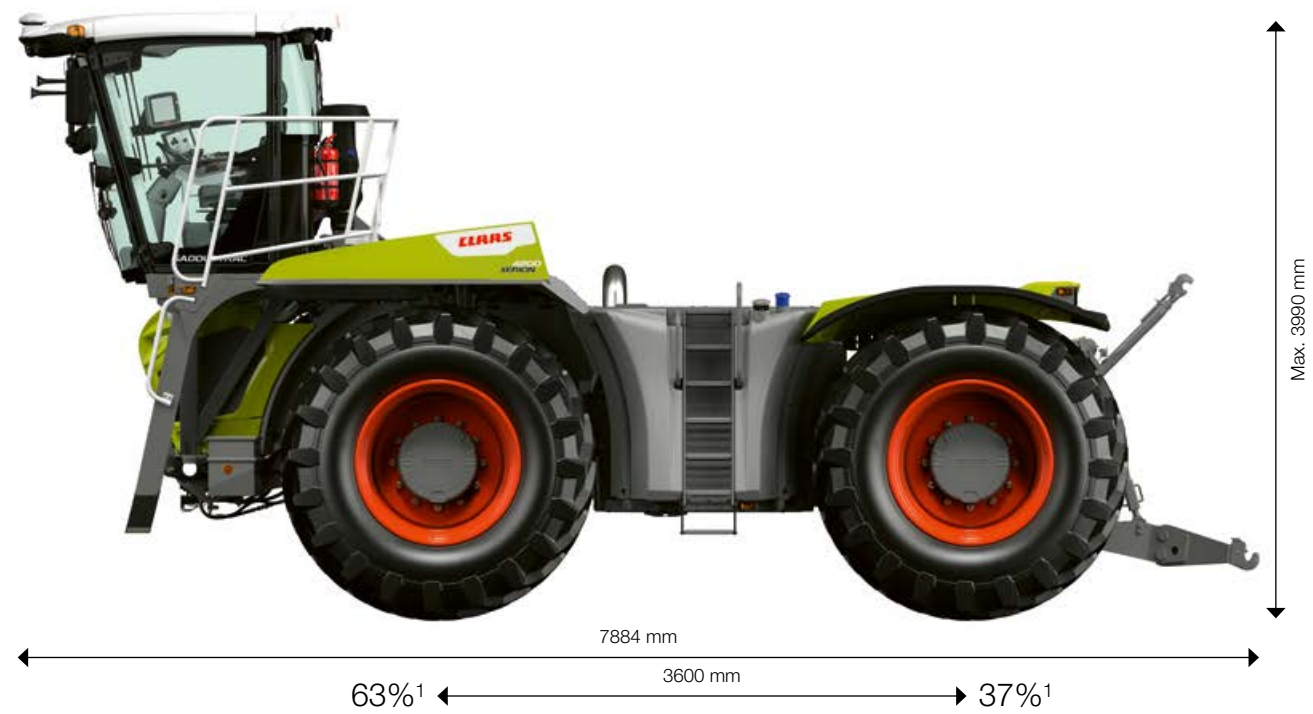

<sup>1</sup> Ideal weight distribution of 63:37 for working with heavy loads



CLAAS KGaA mbH  
 Mühlenwinkel 1  
 33428 Harsewinkel  
 Deutschland  
 Tel. +49 5247 12-0  
 claas.com